

Ground Processing and Launch Facilities

- Historical examples
 - Early Launch Facilities
 - Saturn I
 - Saturn V
 - Russian
- Modern examples
 - Shuttle
 - Delta IV Heavy
 - DC-XA



Cape Canaveral circa 1950



UNIVERSITY OF
MARYLAND

Ground Processing and Launch Facilities
ENAE 791 - Launch and Entry Vehicle Design

Map of Cape Canaveral

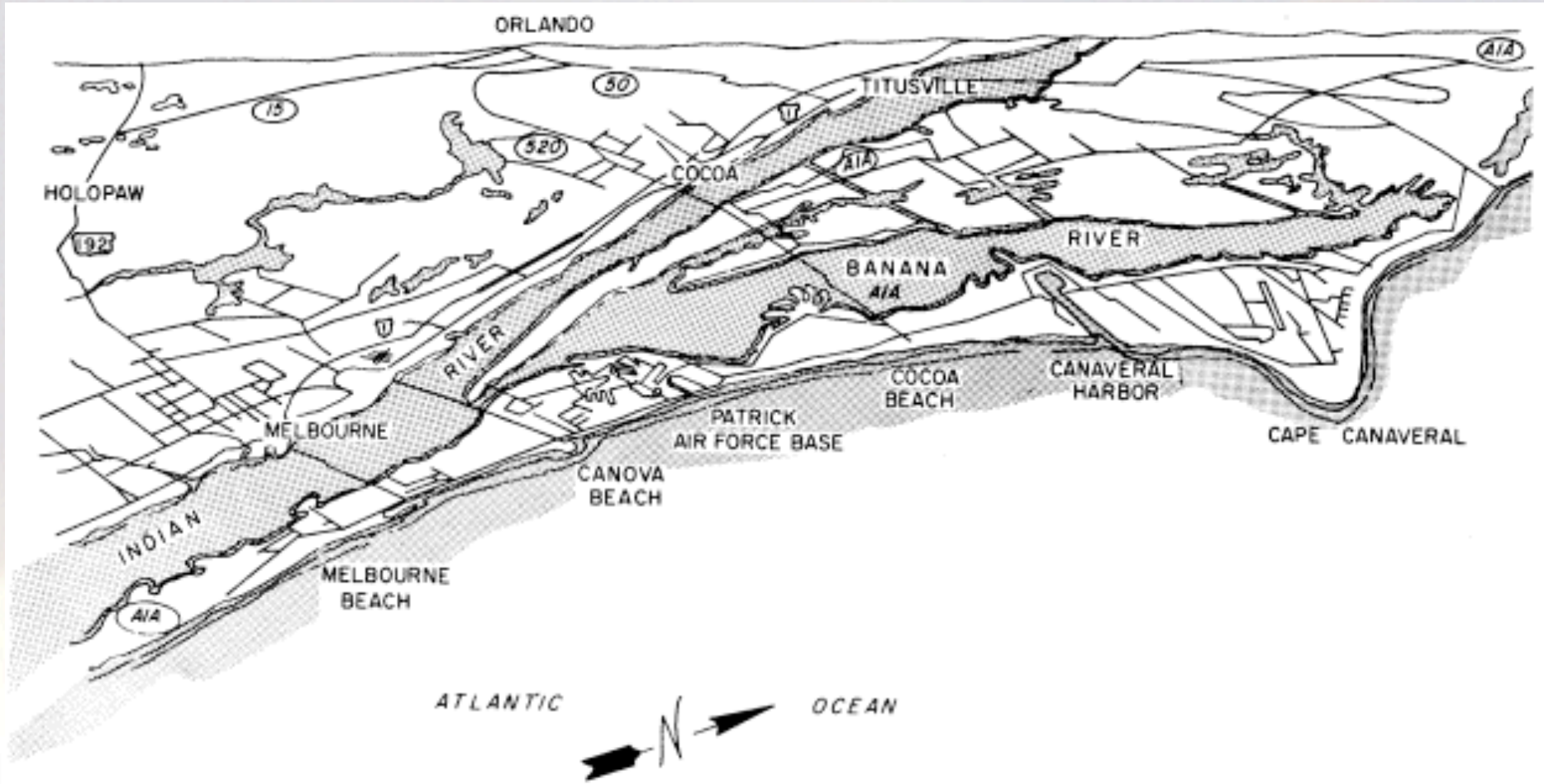

“ICBM Row”



UNIVERSITY OF
MARYLAND

Ground Processing and Launch Facilities
ENAE 791 - Launch and Entry Vehicle Design

LC-5 – Mercury-Redstone



LC-5 Emergency Crew Escape System



UNIVERSITY OF
MARYLAND

Atlas Support Gantry



UNIVERSITY OF
MARYLAND

LC-14 – Mercury-Atlas



UNIVERSITY OF
MARYLAND

Titan II Access Tower Operation



UNIVERSITY OF
MARYLAND

9

Ground Processing and Launch Facilities
ENAE 791 - Launch and Entry Vehicle Design

LC-34 Schematic



UNIVERSITY OF
MARYLAND

Ground Processing and Launch Facilities
ENAE 791 - Launch and Entry Vehicle Design

Saturn I Launch Pedestal

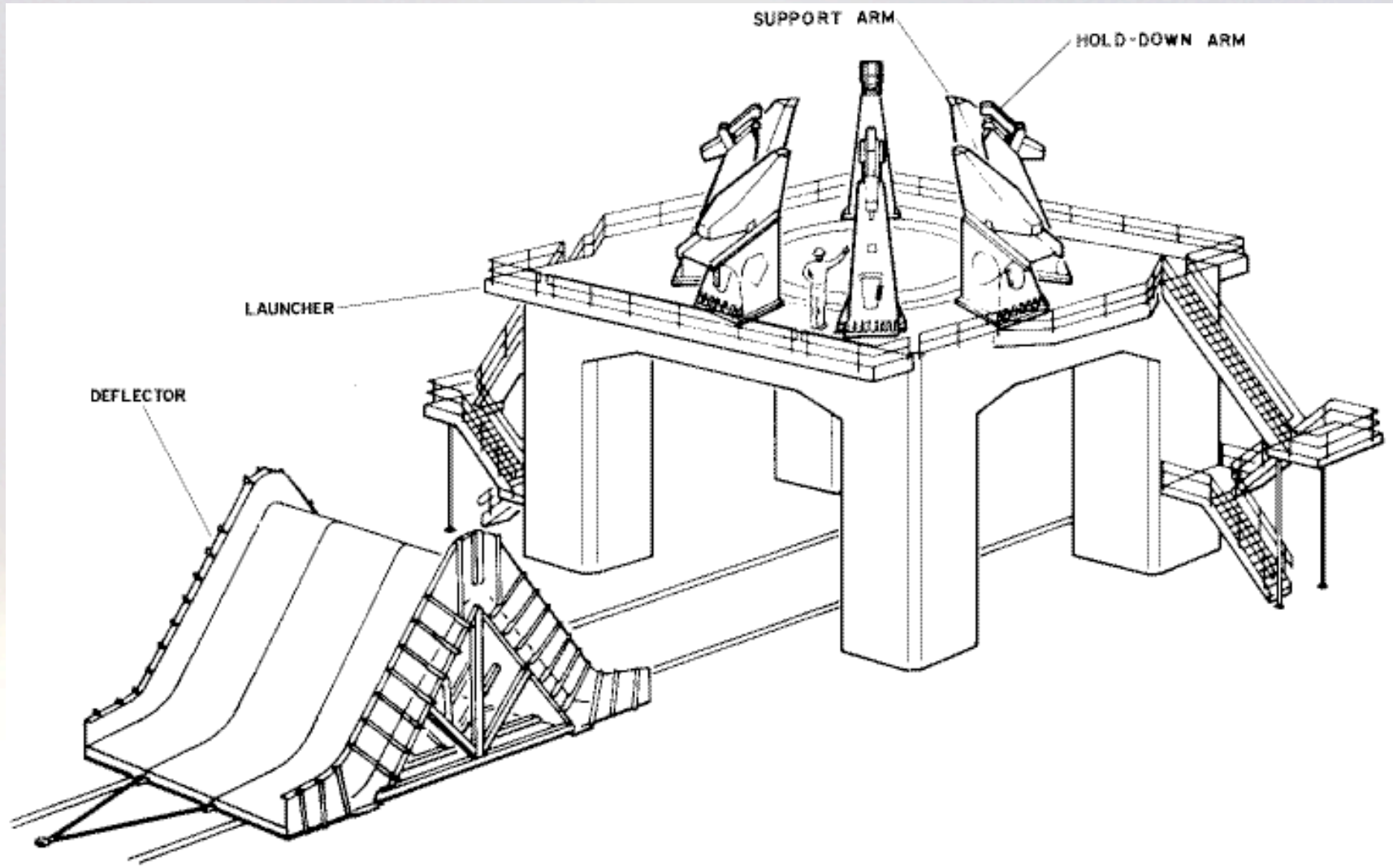

LC-34 Launch Pedestal Under Construction



UNIVERSITY OF
MARYLAND

Ground Processing and Launch Facilities
ENAE 791 - Launch and Entry Vehicle Design

LC-34 Flame Deflector



UNIVERSITY OF
MARYLAND

Ground Processing and Launch Facilities
ENAE 791 - Launch and Entry Vehicle Design

LC-34 Blockhouse



UNIVERSITY OF
MARYLAND

Ground Processing and Launch Facilities
ENAE 791 - Launch and Entry Vehicle Design

LC-34 Service Structure

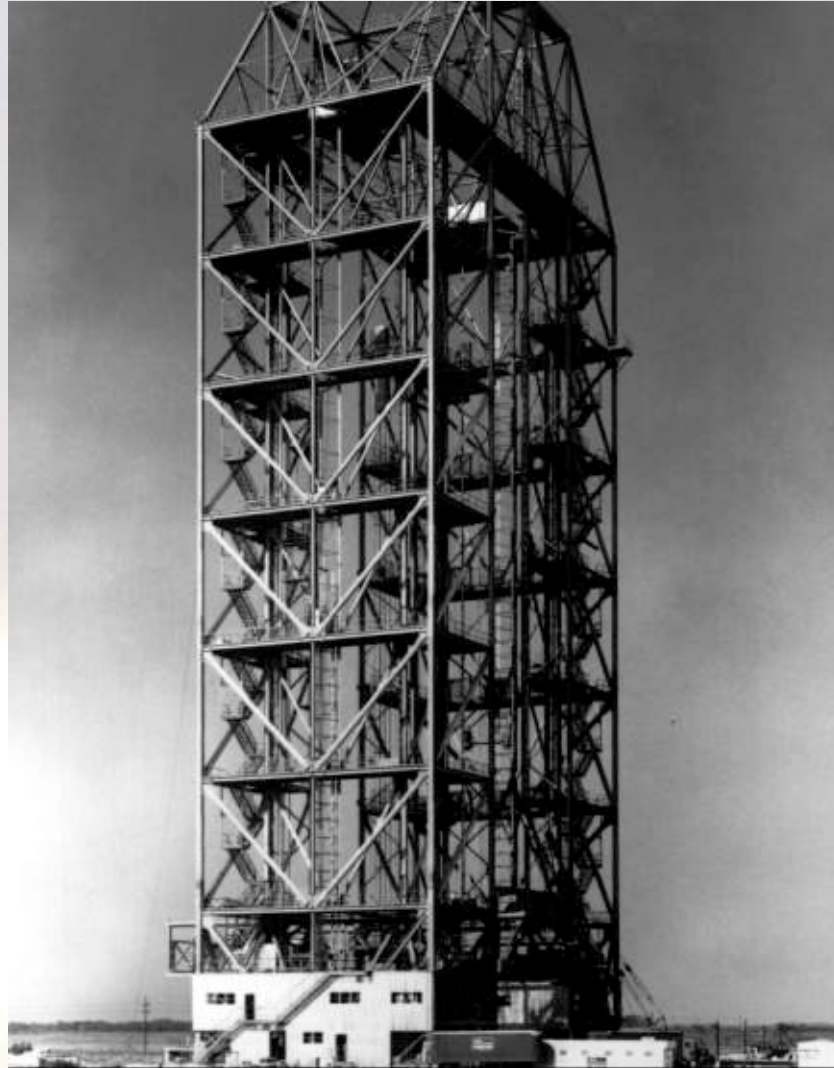

UNIVERSITY OF
MARYLAND

Ground Processing and Launch Facilities
ENAE 791 - Launch and Entry Vehicle Design

Saturn I Erection Process

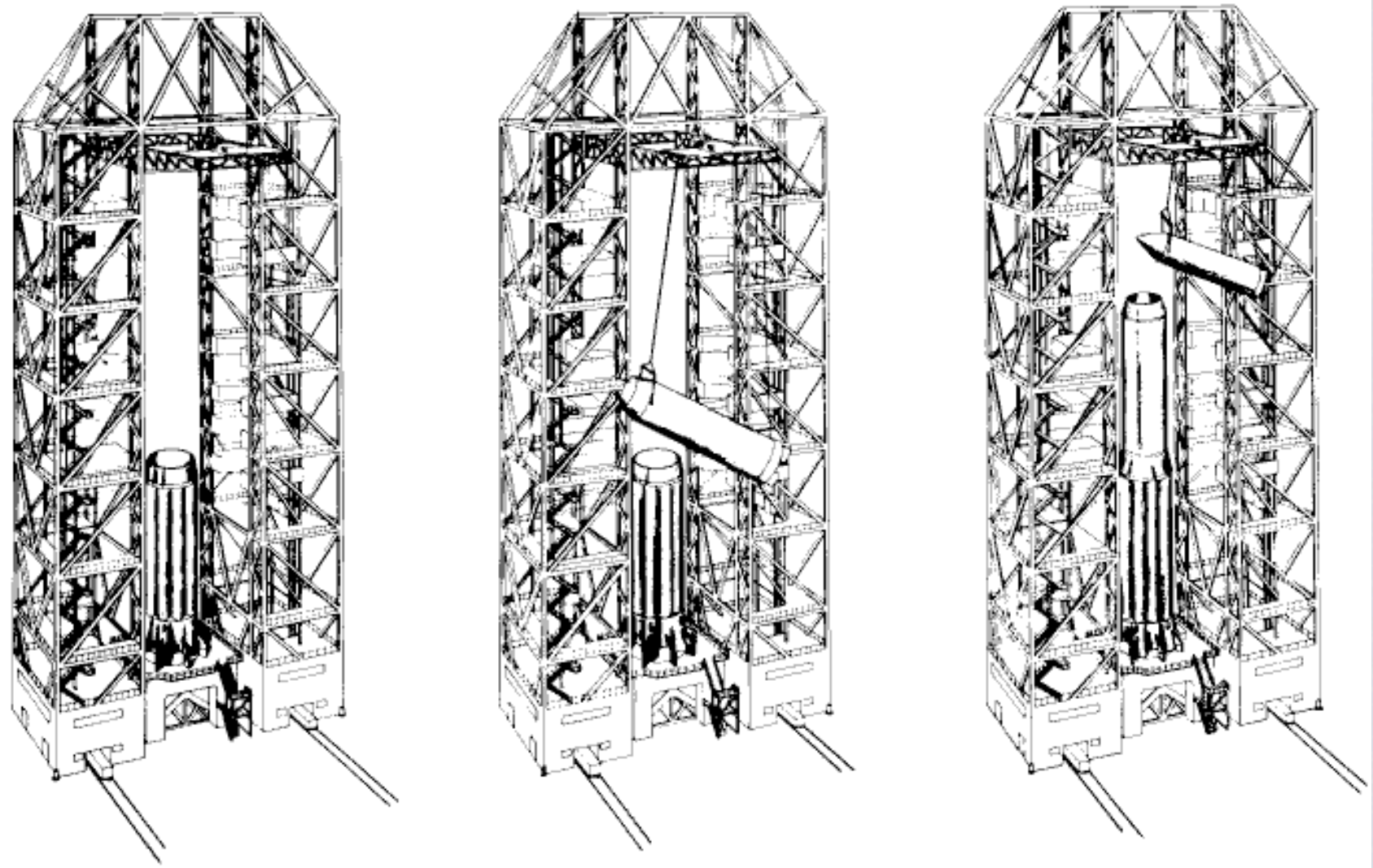

Aerial View of LC-34



UNIVERSITY OF
MARYLAND

Ground Processing and Launch Facilities
ENAE 791 - Launch and Entry Vehicle Design

Aerial View of LC-34



UNIVERSITY OF
MARYLAND

Ground Processing and Launch Facilities
ENAE 791 - Launch and Entry Vehicle Design

Aerial View of LC-34



UNIVERSITY OF
MARYLAND

Ground Processing and Launch Facilities
ENAE 791 - Launch and Entry Vehicle Design

S-I Stage Rotation



UNIVERSITY OF
MARYLAND

Ground Processing and Launch Facilities
ENAE 791 - Launch and Entry Vehicle Design

S-I Stage Rotation



UNIVERSITY OF
MARYLAND

Ground Processing and Launch Facilities
ENAE 791 - Launch and Entry Vehicle Design

Assembly of Saturn I



UNIVERSITY OF
MARYLAND

Ground Processing and Launch Facilities
ENAE 791 - Launch and Entry Vehicle Design

SA-201 Launch

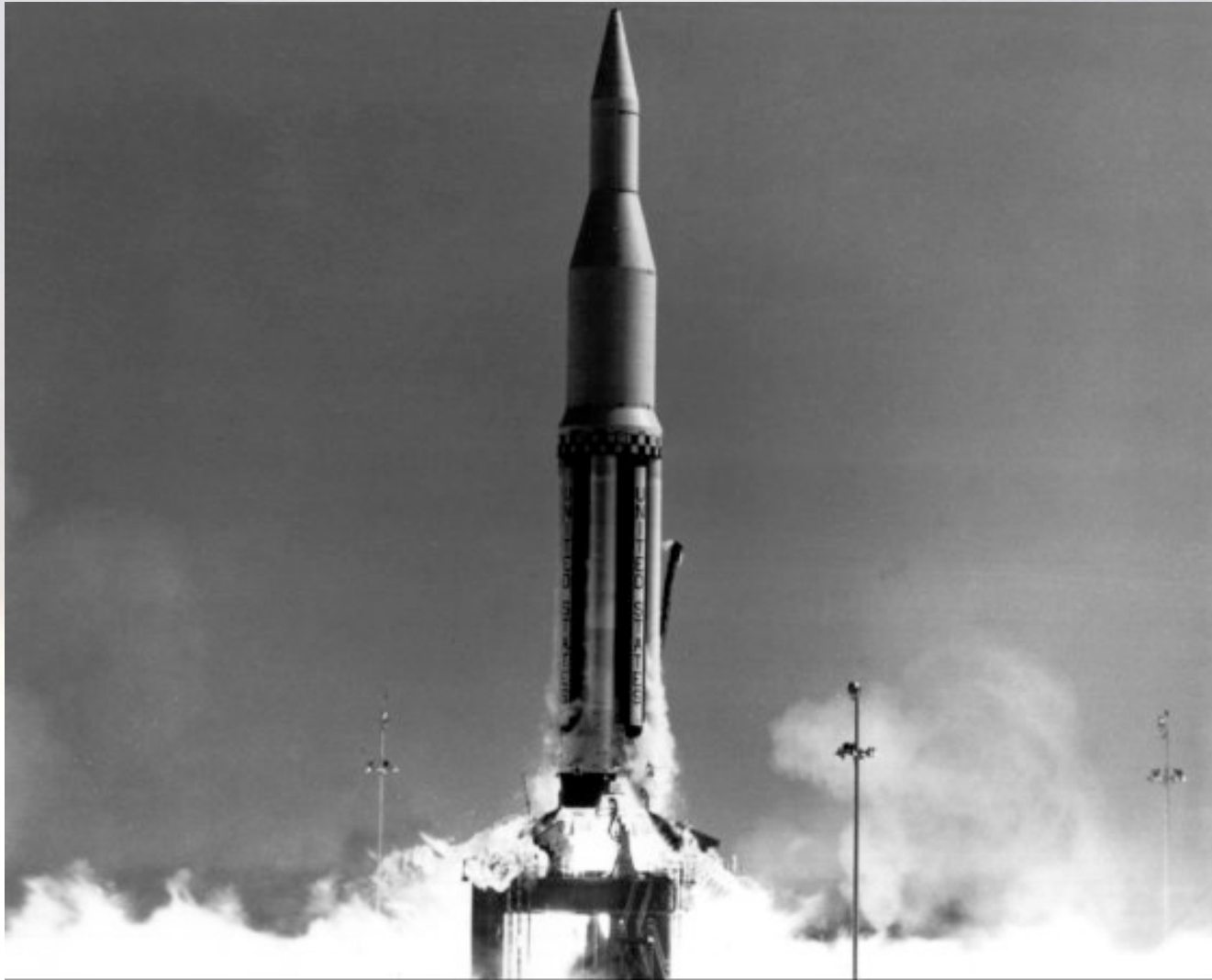

UNIVERSITY OF
MARYLAND

Ground Processing and Launch Facilities
ENAE 791 - Launch and Entry Vehicle Design

LC-37 Concept

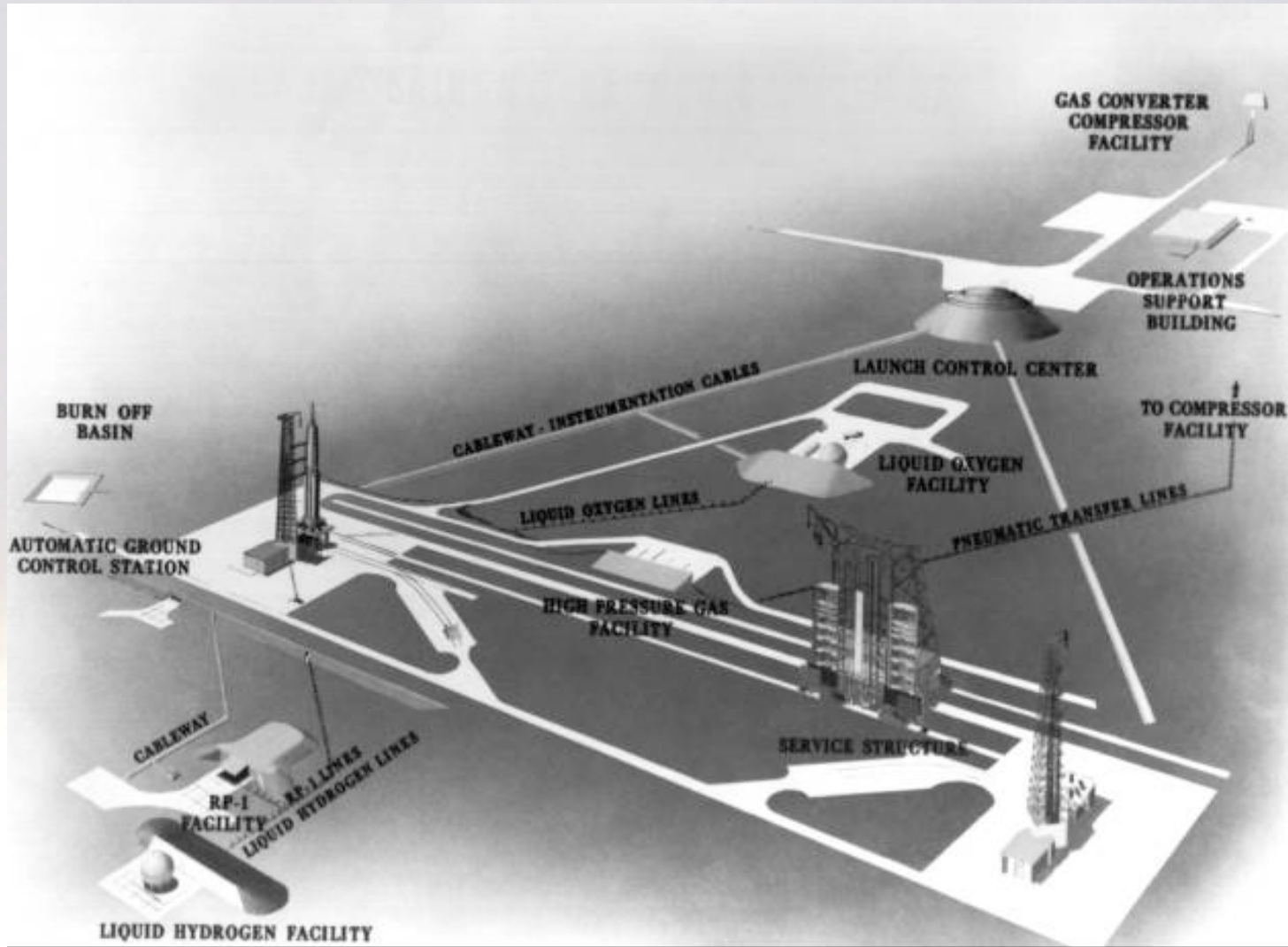

LC-37 Under Construction (1963)



UNIVERSITY OF
MARYLAND

Ground Processing and Launch Facilities
ENAE 791 - Launch and Entry Vehicle Design

LC-37 Construction Photo



UNIVERSITY OF
MARYLAND

Ground Processing and Launch Facilities
ENAE 791 - Launch and Entry Vehicle Design

Barge Transport of Launch Vehicle Stages

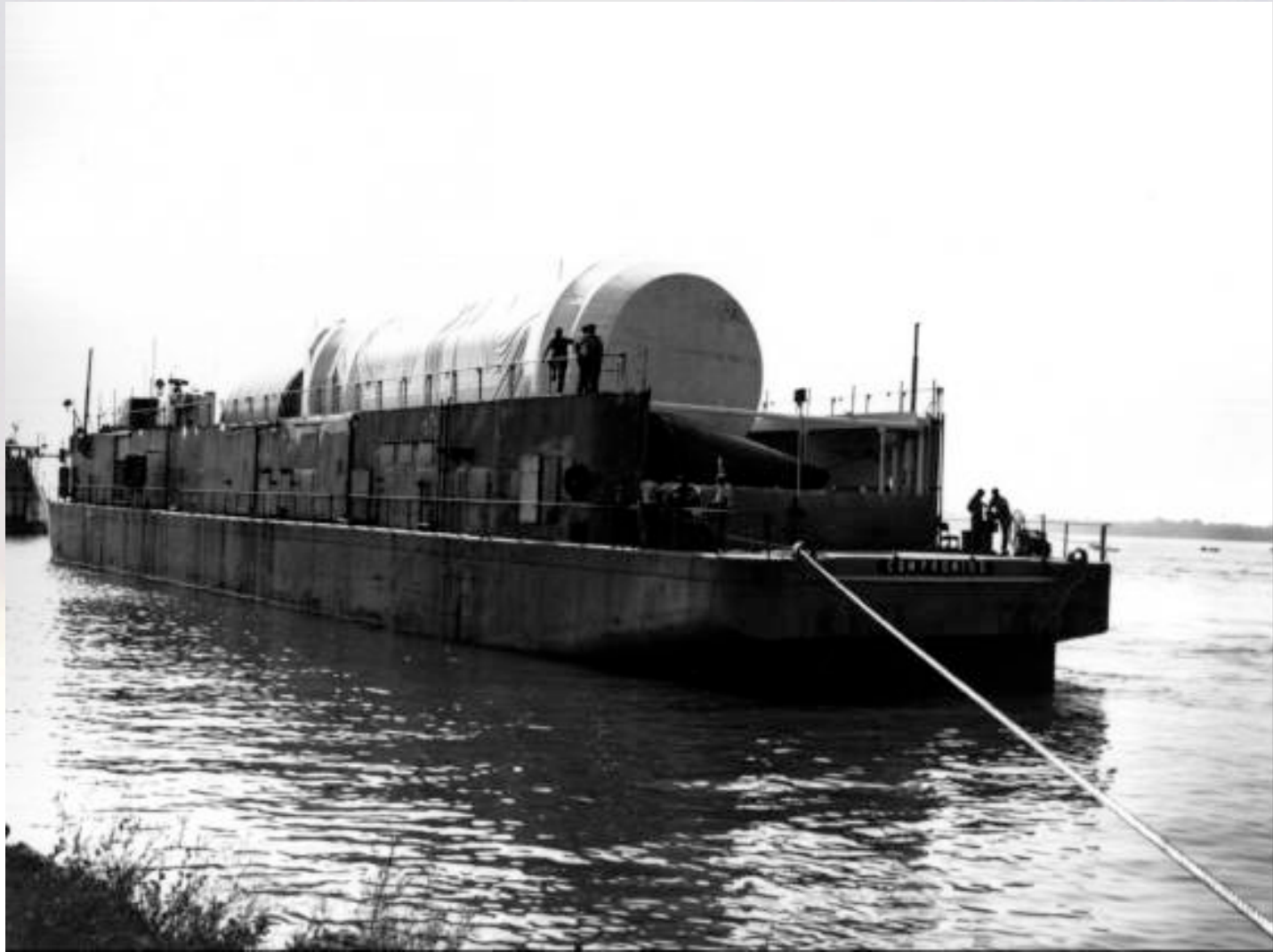

UNIVERSITY OF
MARYLAND

Ground Processing and Launch Facilities
ENAE 791 - Launch and Entry Vehicle Design

Aerial Transport of Stages



UNIVERSITY OF
MARYLAND

Ground Processing and Launch Facilities
ENAE 791 - Launch and Entry Vehicle Design

Cape Canaveral Siting Map

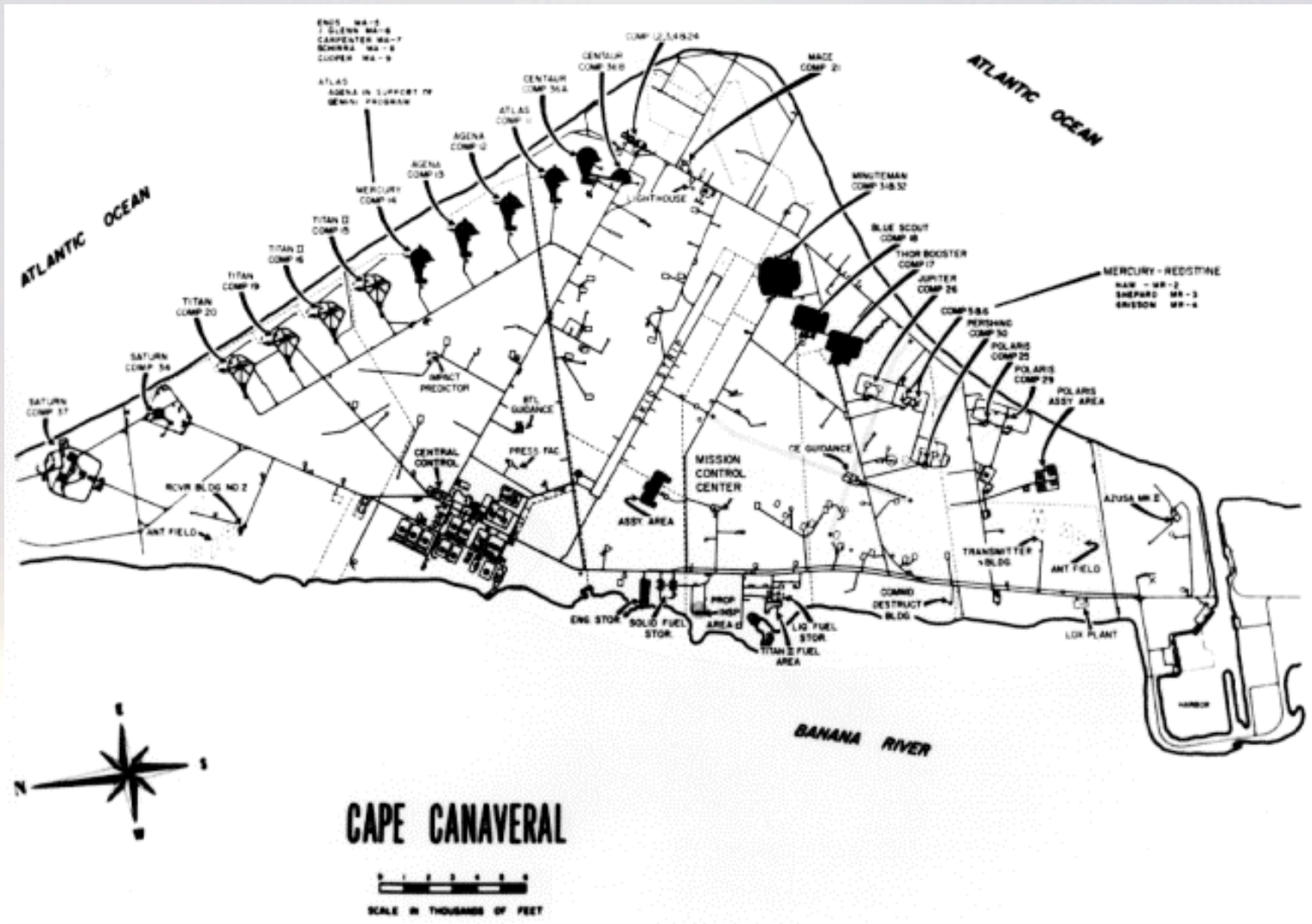

Launch Sites Considered for Apollo

- Cape Canaveral
- Offshore from Cape Canaveral
- Mayaguana Island in the Bahamas
- Cumberland Island, Georgia
- A mainland site near Brownsville, Texas
- White Sands Missile Range in New Mexico
- Christmas Island in the mid-Pacific south of Hawaii
- South Point on the island of Hawaii



Early Mobile Launch Complex Concept

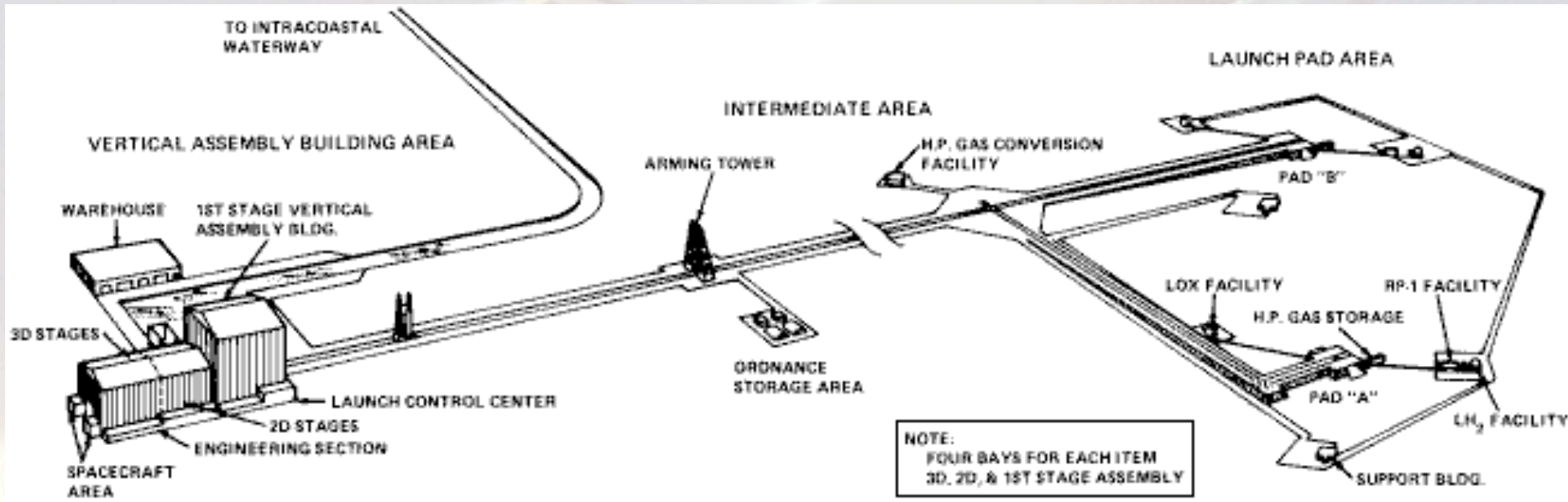

Concept of an Off-Shore Launch Facility

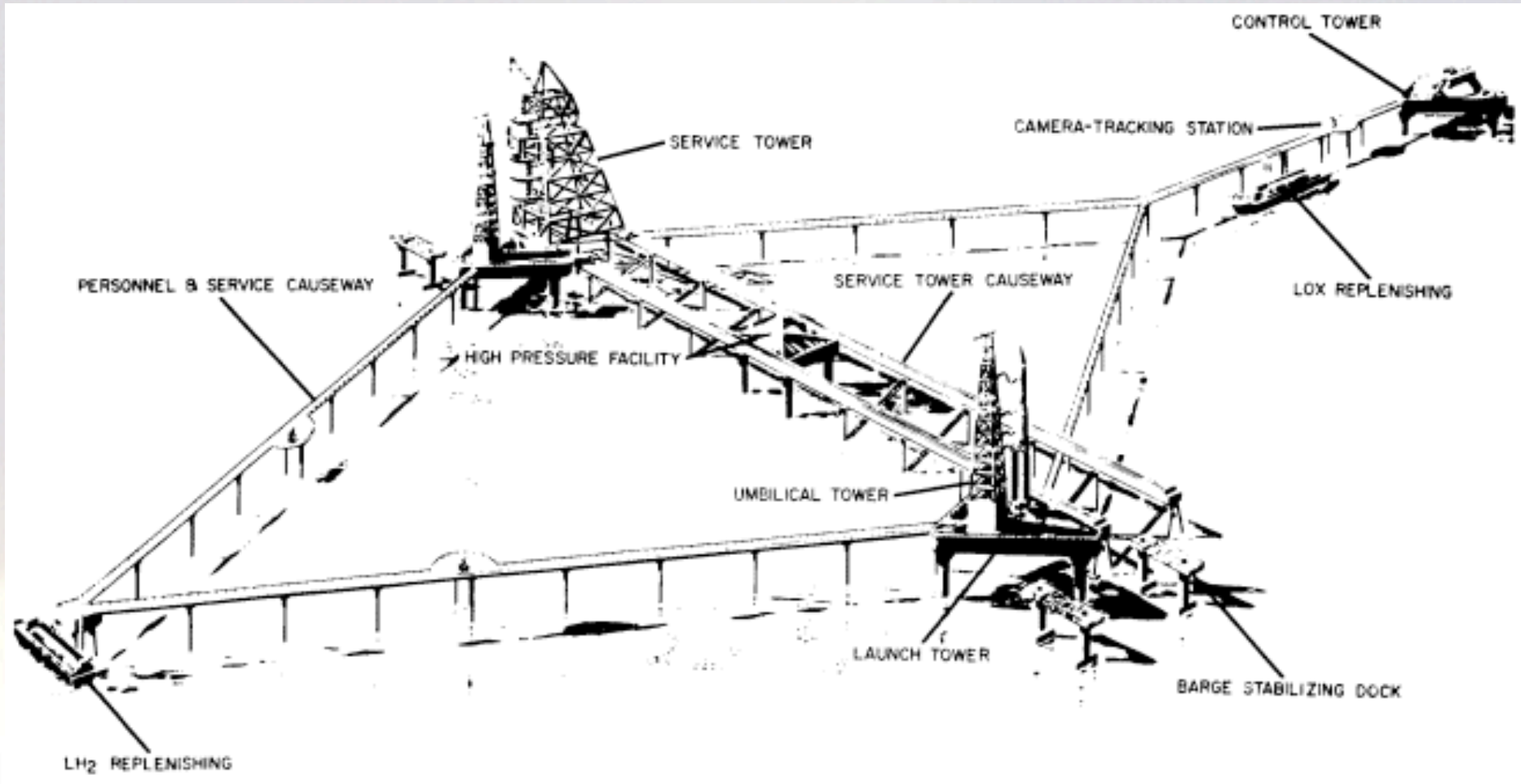

Merritt Island Launch Area (MILA)

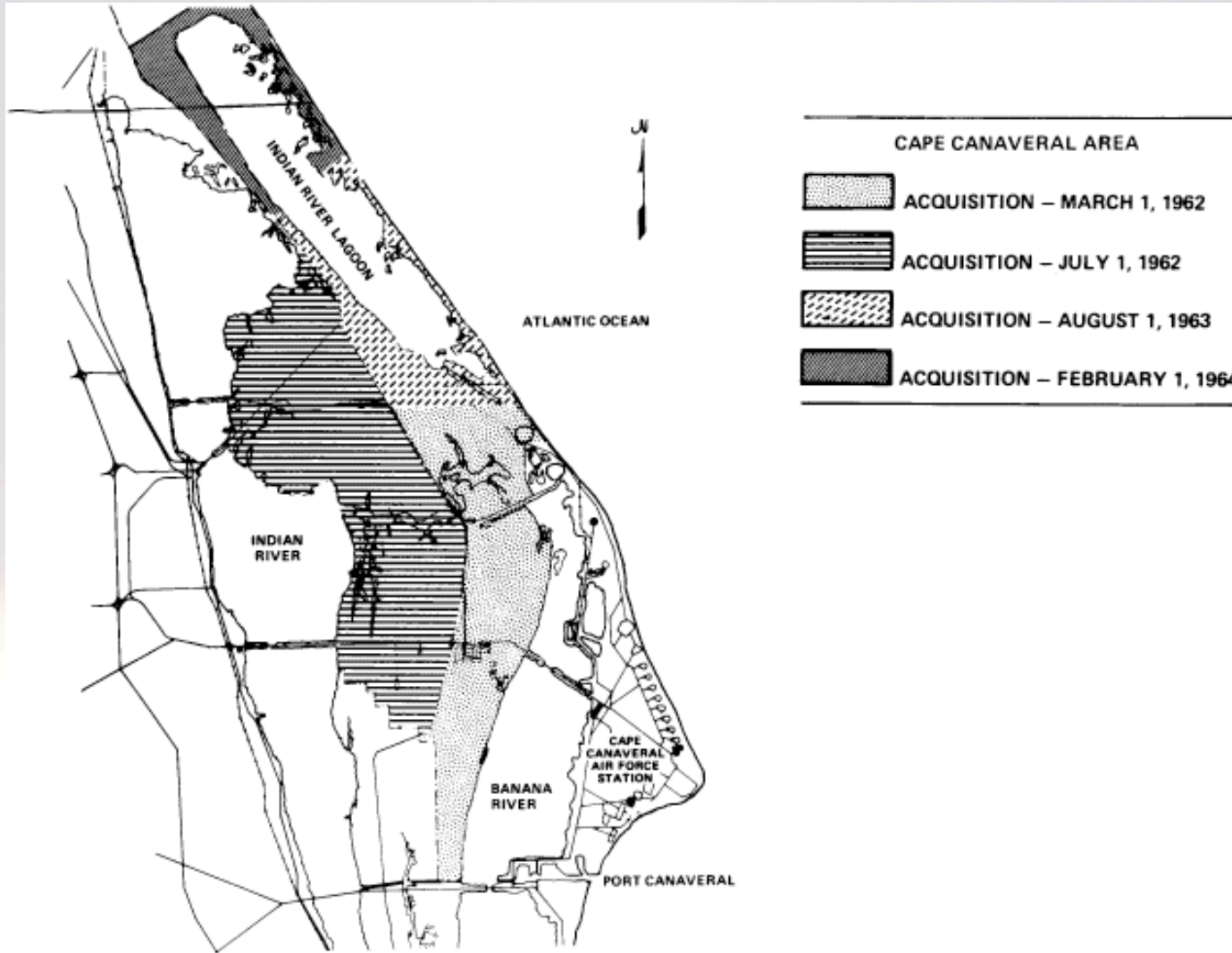

Map of KSC and CCAFS



Competition for MILA Launch Sites

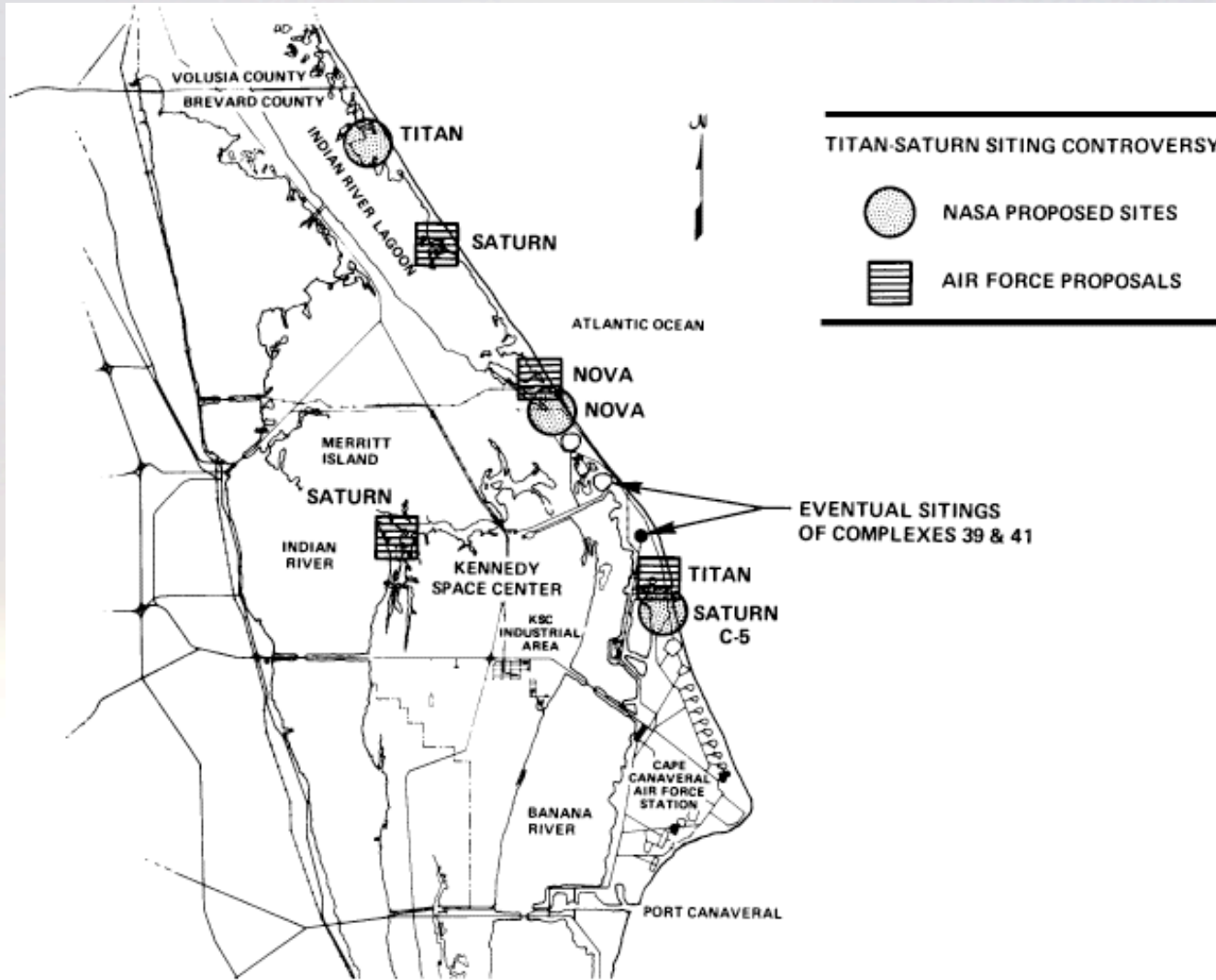

Rail-Based Nova Launch Concept

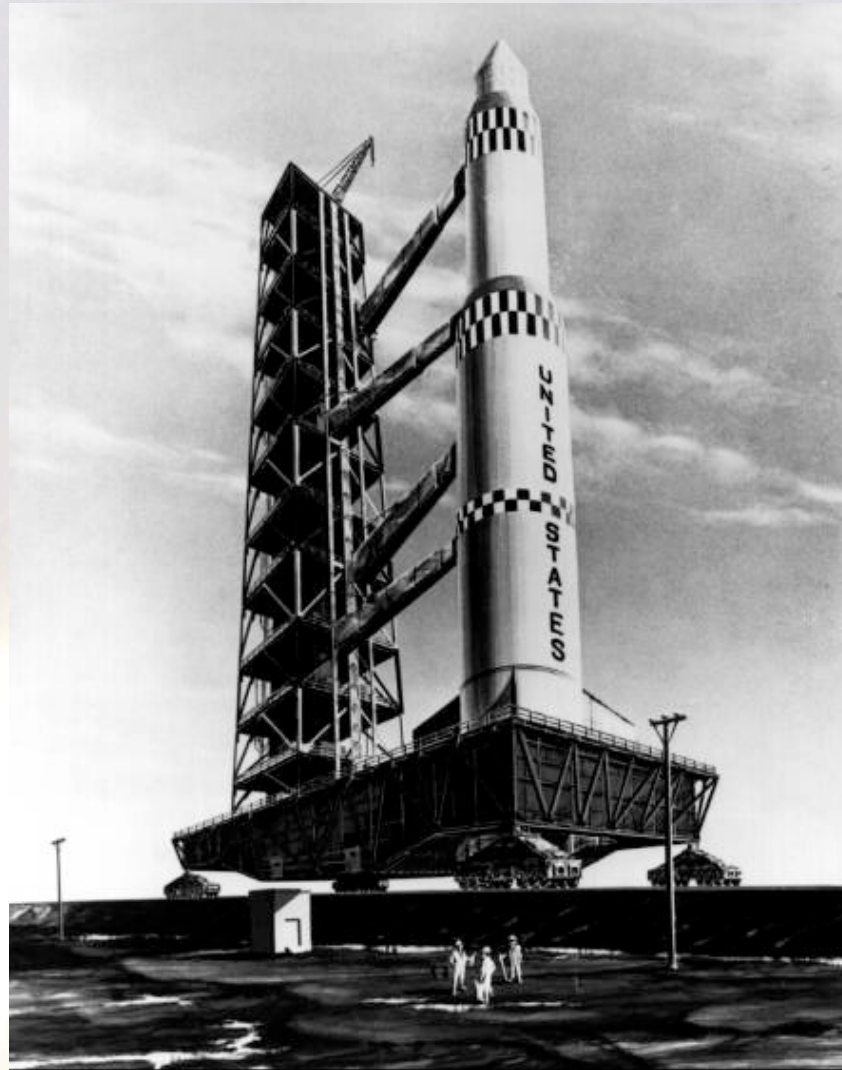

UNIVERSITY OF
MARYLAND

Ground Processing and Launch Facilities
ENAE 791 - Launch and Entry Vehicle Design

Barge-Based Saturn V Launch Concept

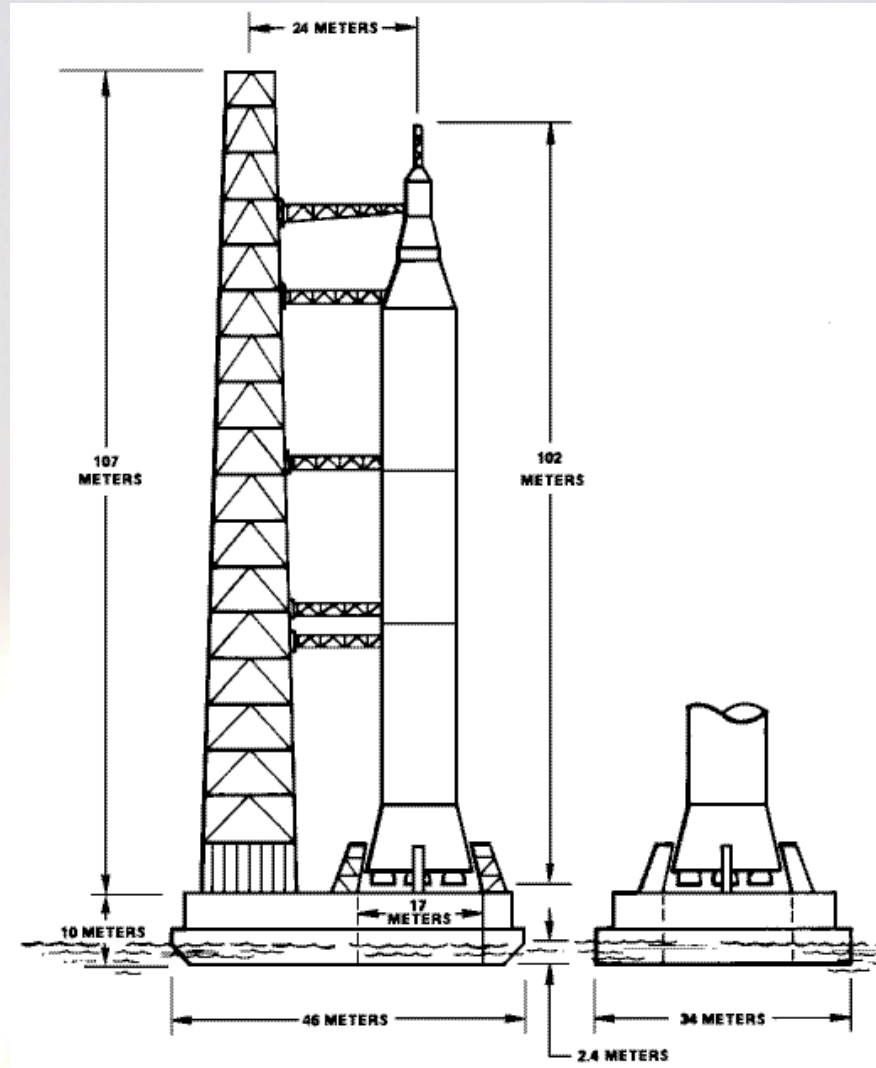

Barge-Based Vertical Assembly Building

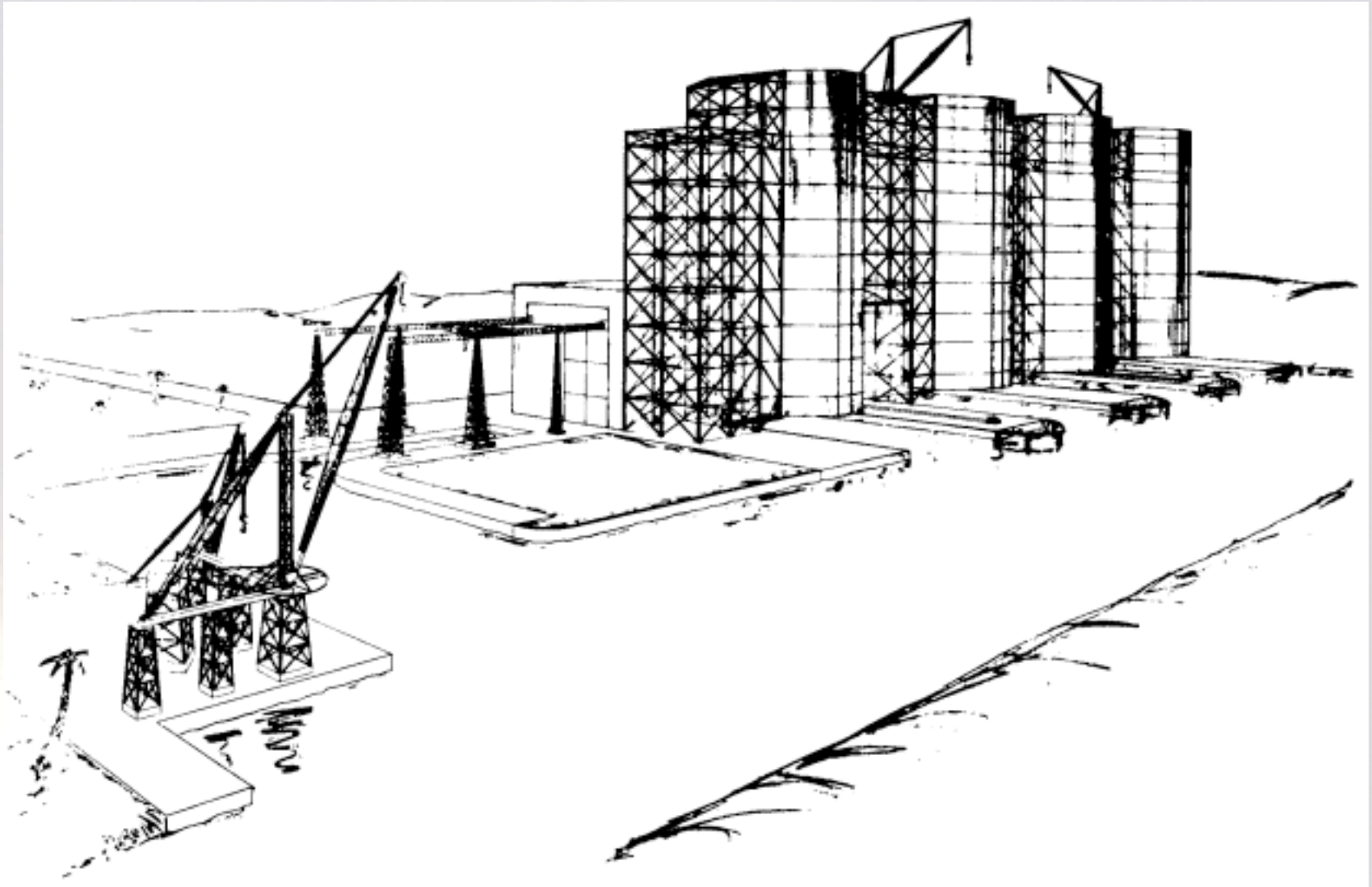

UNIVERSITY OF
MARYLAND

Ground Processing and Launch Facilities
ENAE 791 - Launch and Entry Vehicle Design

Barge-Based VAB (Enclosed)

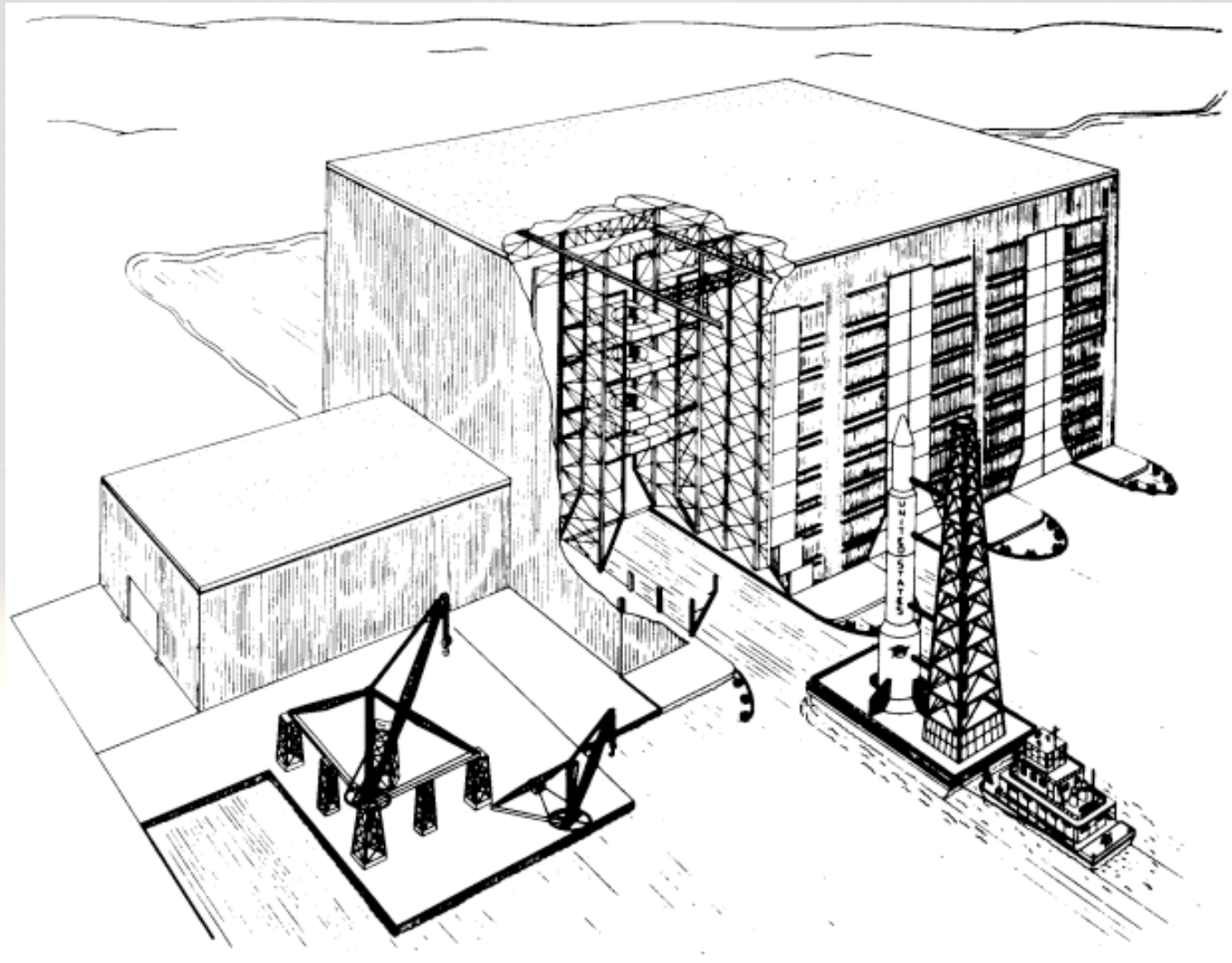

Interior Concept of VAB

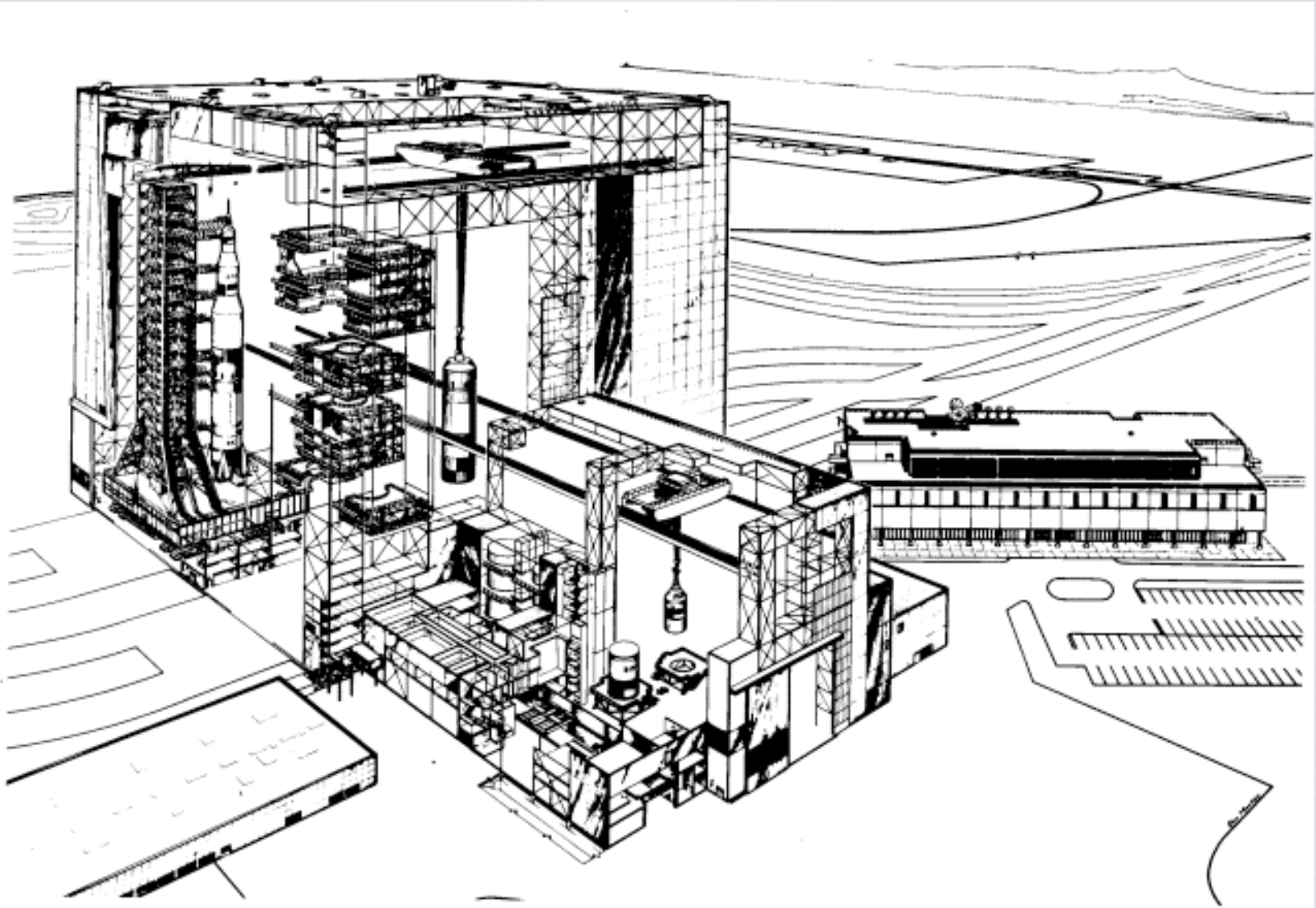

UNIVERSITY OF
MARYLAND

Ground Processing and Launch Facilities
ENAE 791 - Launch and Entry Vehicle Design

Early Construction of VAB



UNIVERSITY OF
MARYLAND

Ground Processing and Launch Facilities
ENAE 791 - Launch and Entry Vehicle Design

VAB and LCC Under Construction



UNIVERSITY OF
MARYLAND

Ground Processing and Launch Facilities
ENAE 791 - Launch and Entry Vehicle Design

VAB from Turning Basin

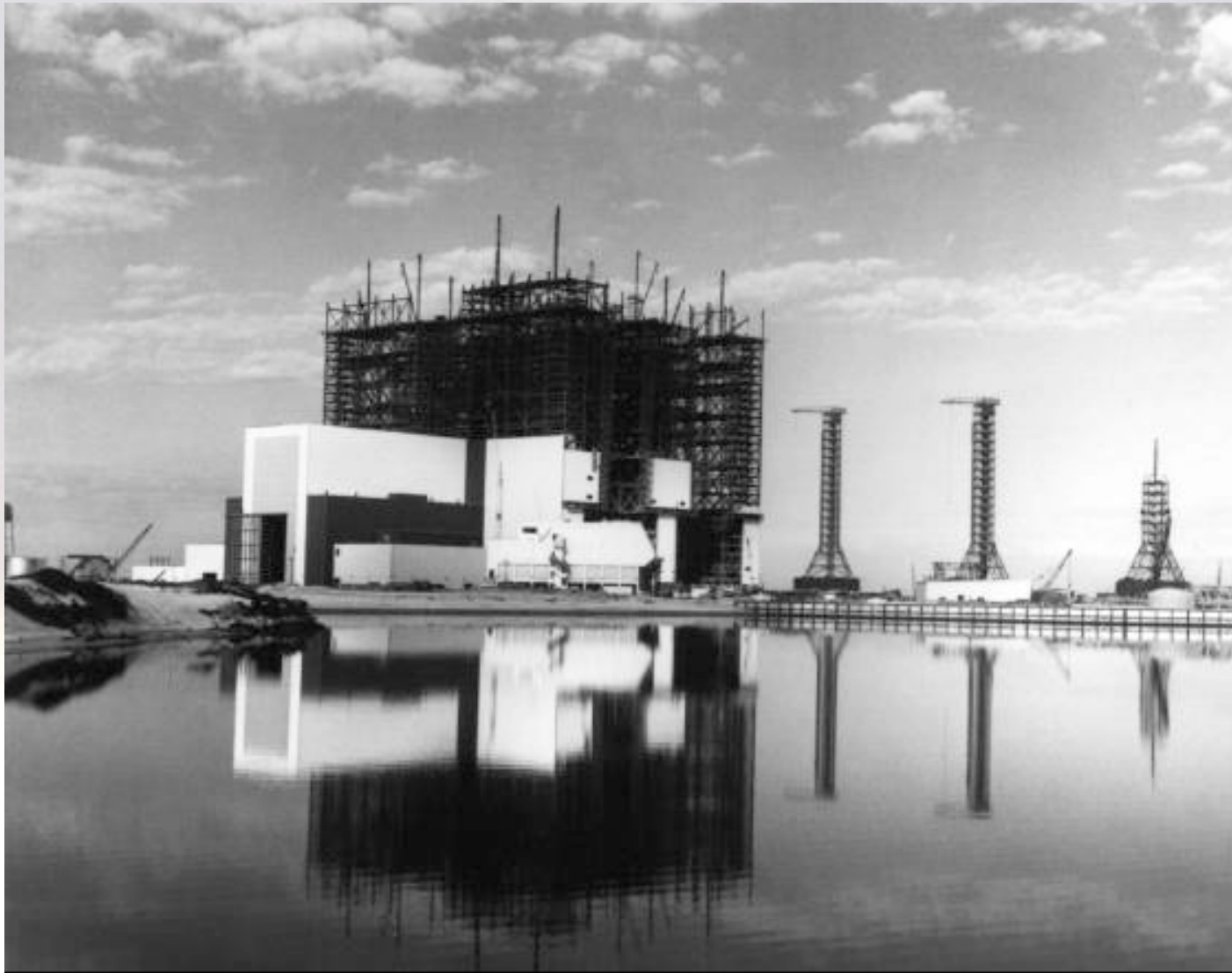

UNIVERSITY OF
MARYLAND

Ground Processing and Launch Facilities
ENAE 791 - Launch and Entry Vehicle Design

Interior of Launch Control Center



Interior of Launch Control Center



UNIVERSITY OF
MARYLAND

Ground Processing and Launch Facilities
ENAE 791 - Launch and Entry Vehicle Design

Early Concept of Mobile Launch Platform

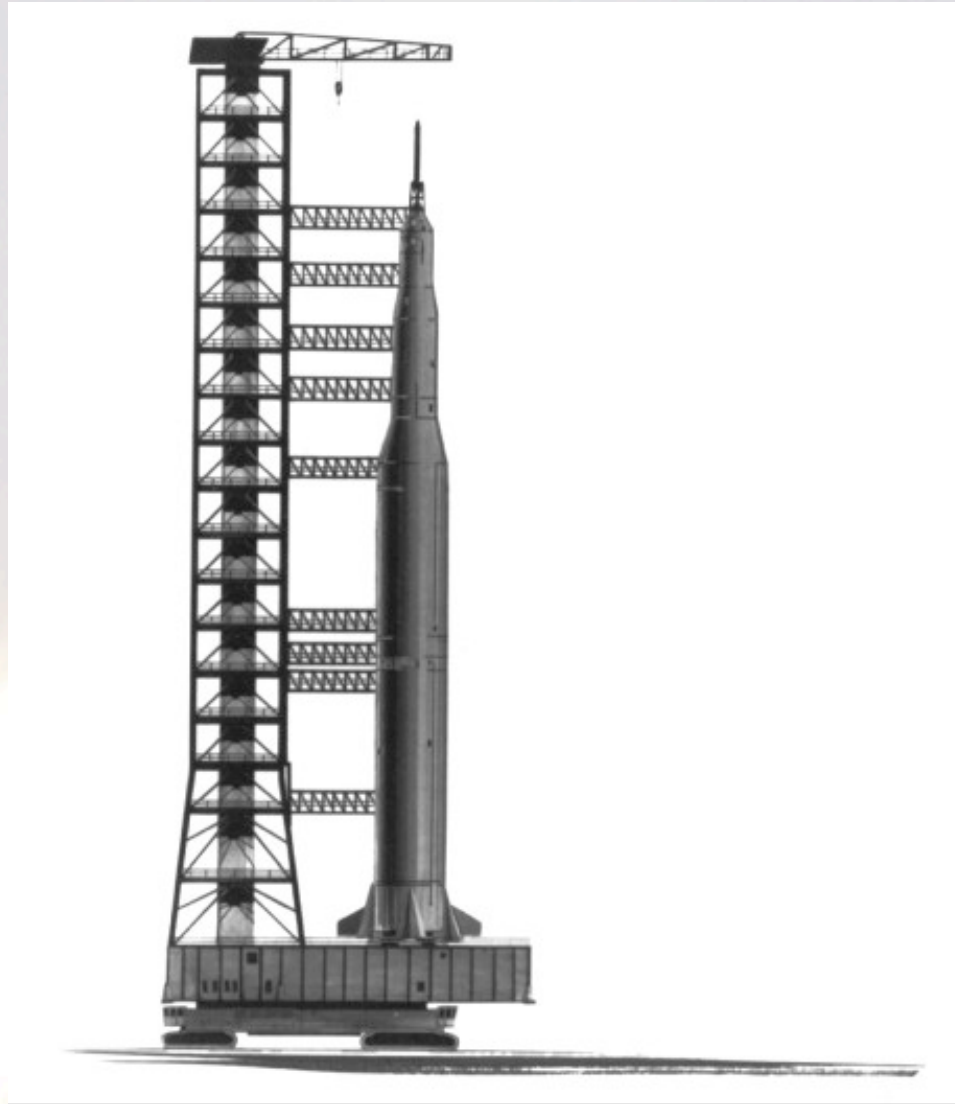

UNIVERSITY OF
MARYLAND

Ground Processing and Launch Facilities
ENAE 791 - Launch and Entry Vehicle Design

West Virginia Strip-Mine Coal Shovel

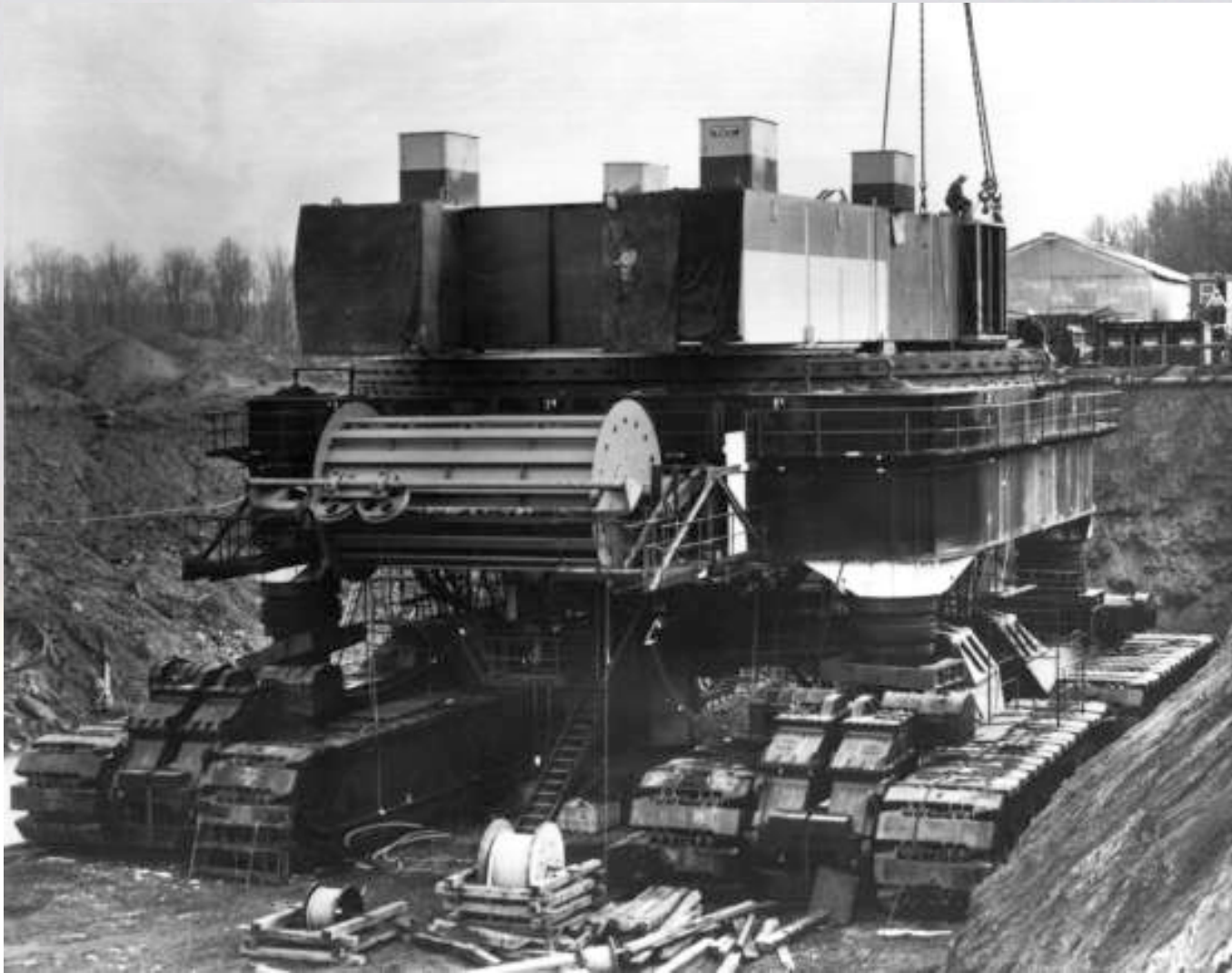

UNIVERSITY OF
MARYLAND

Ground Processing and Launch Facilities
ENAE 791 - Launch and Entry Vehicle Design

Crawler-Transporter



UNIVERSITY OF
MARYLAND

Ground Processing and Launch Facilities
ENAE 791 - Launch and Entry Vehicle Design

Cutaway of Crawler-Transporter

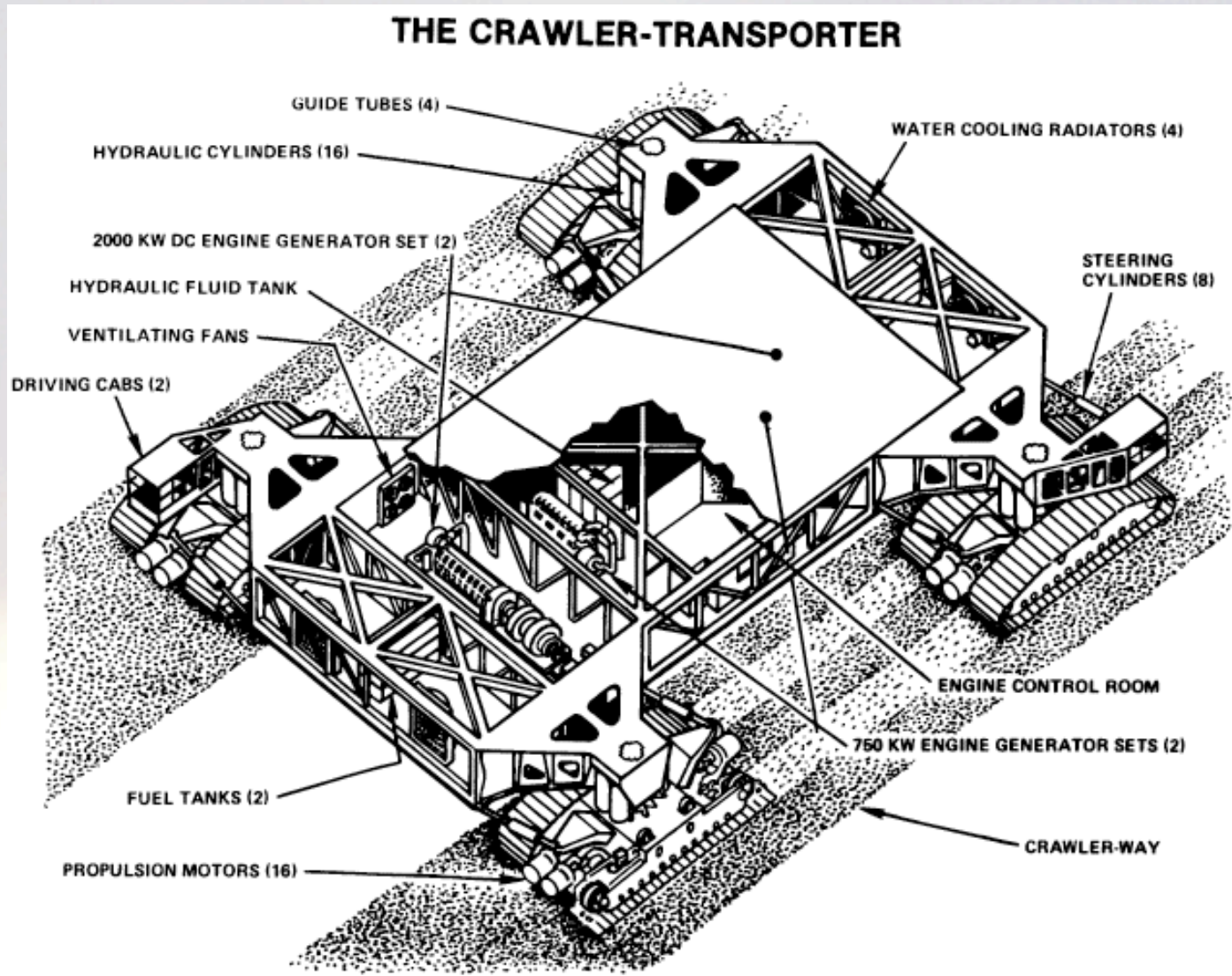

Complex 39 Crawlerway

PROFILE OF TYPICAL CRAWLERWAY SECTION

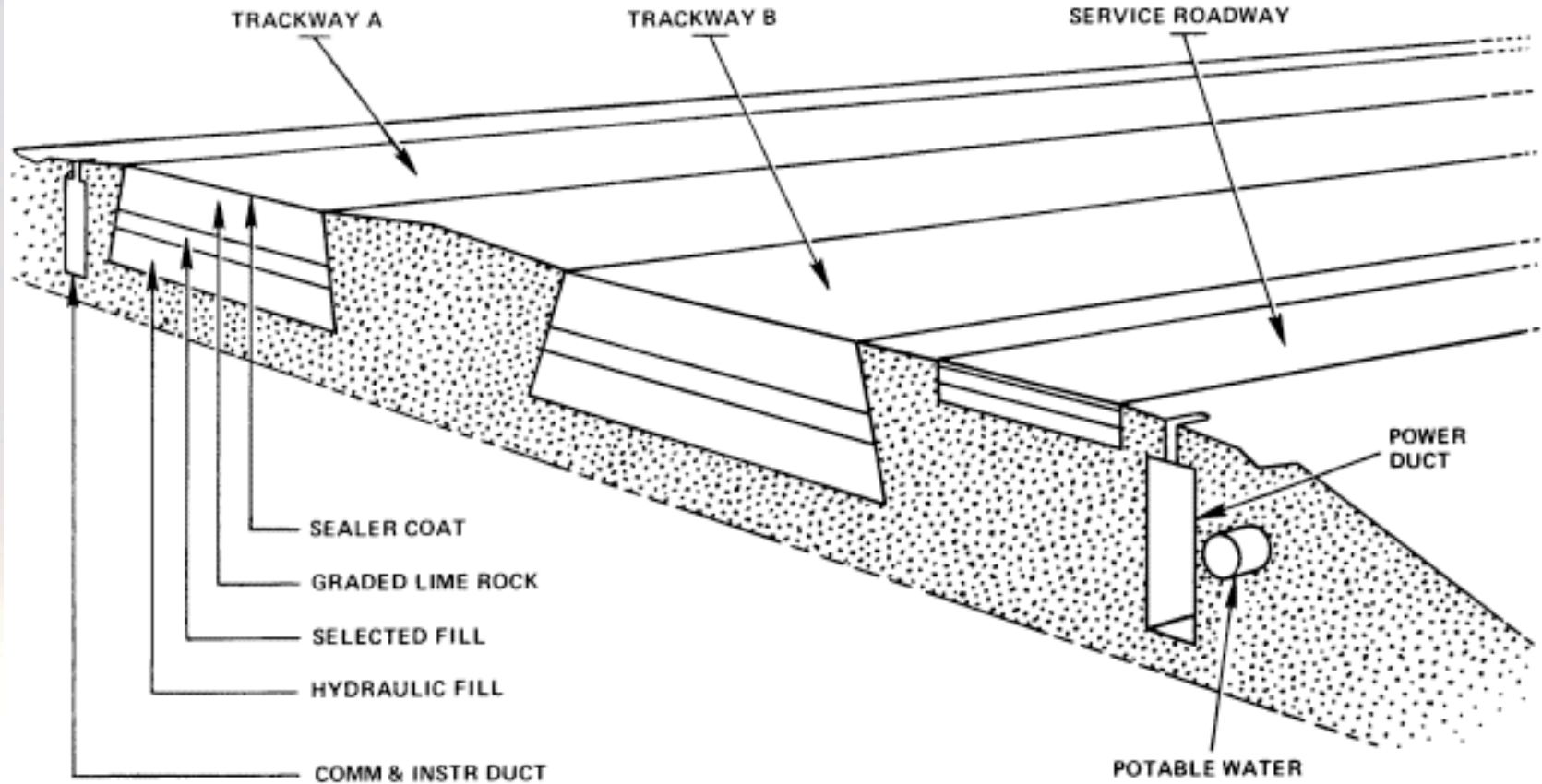

(NOT TO SCALE)



Saturn V Mobile Launch Platforms



UNIVERSITY OF
MARYLAND

Ground Processing and Launch Facilities
ENAE 791 - Launch and Entry Vehicle Design

MLP Transport Tests

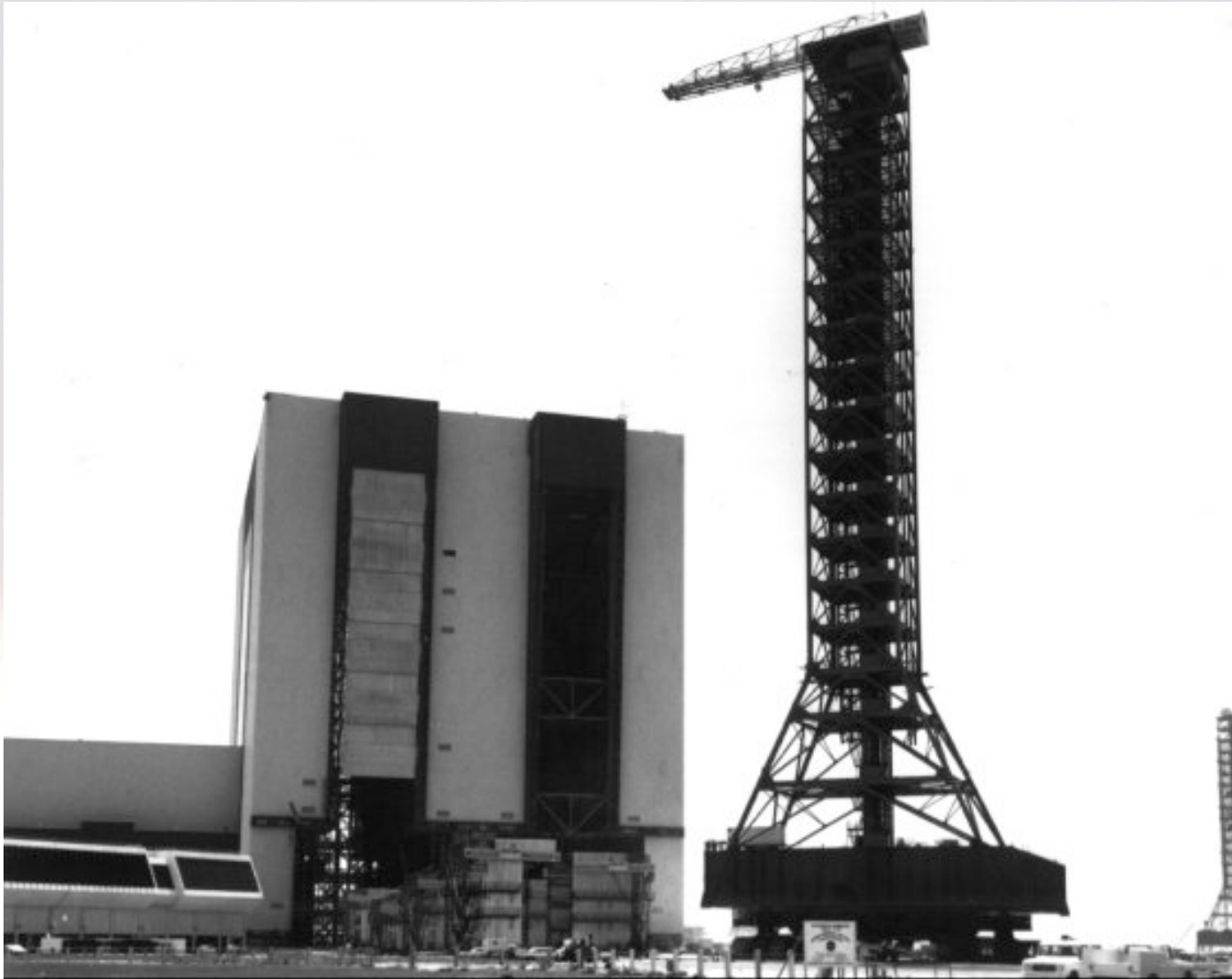

UNIVERSITY OF
MARYLAND

Ground Processing and Launch Facilities
ENAE 791 - Launch and Entry Vehicle Design

Interior of VAB

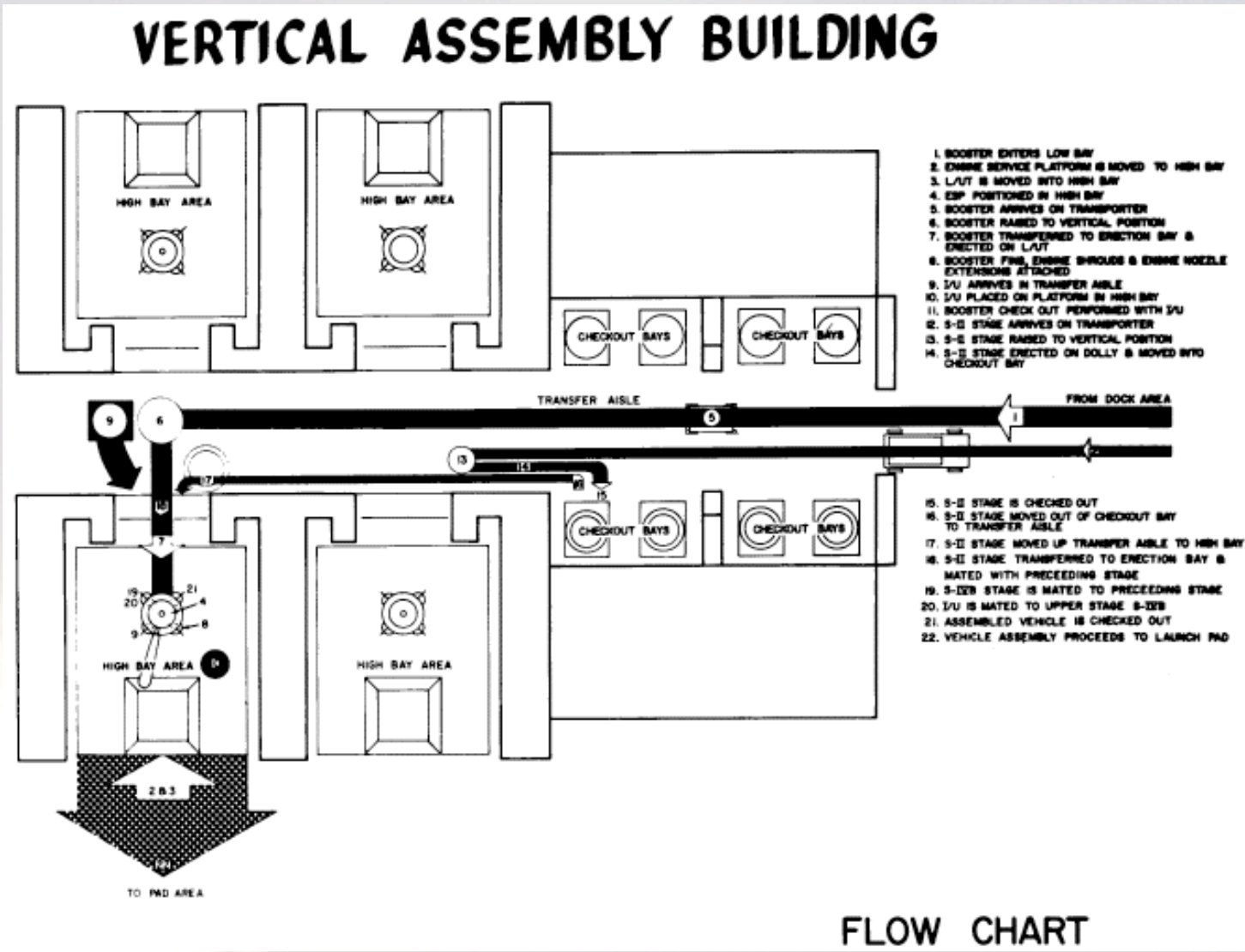

S-IC Stage in VAB Transfer Aisle



UNIVERSITY OF
MARYLAND

Ground Processing and Launch Facilities
ENAE 791 - Launch and Entry Vehicle Design

S-IC – S-II Stacking

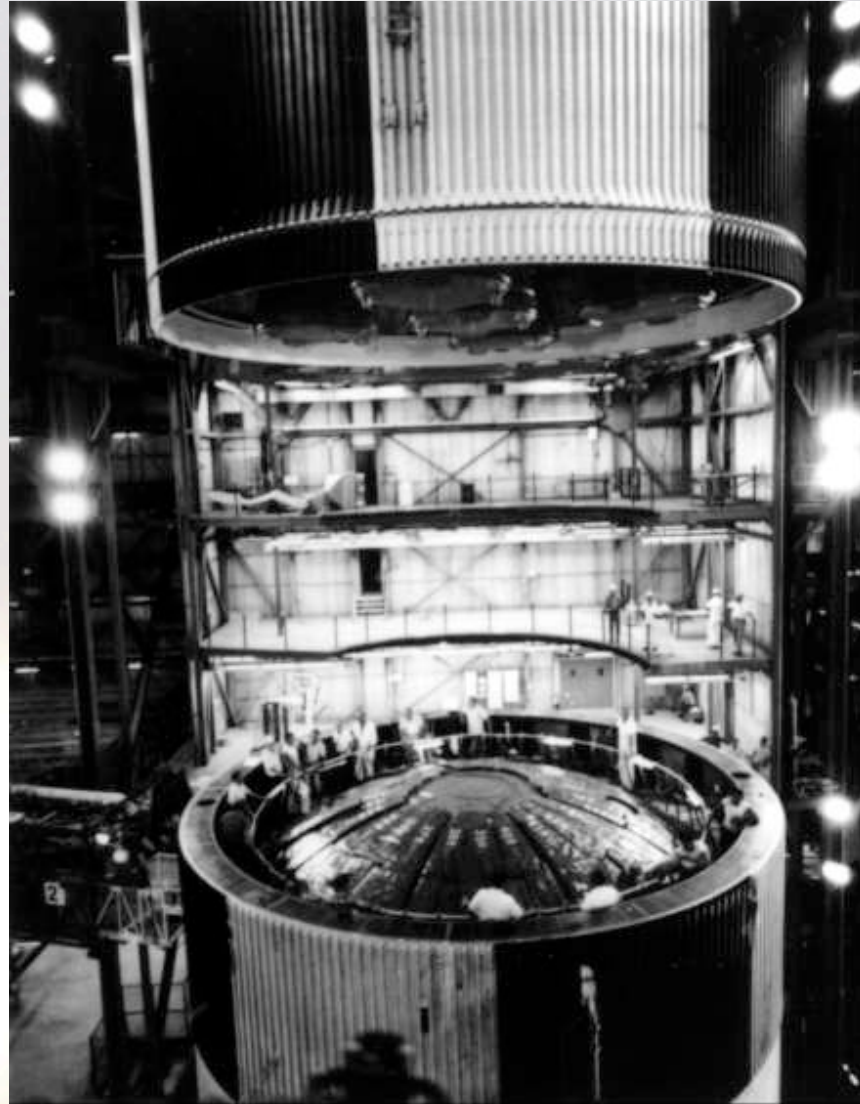

UNIVERSITY OF
MARYLAND

Ground Processing and Launch Facilities
ENAE 791 - Launch and Entry Vehicle Design

S-II – S-IVB Stacking

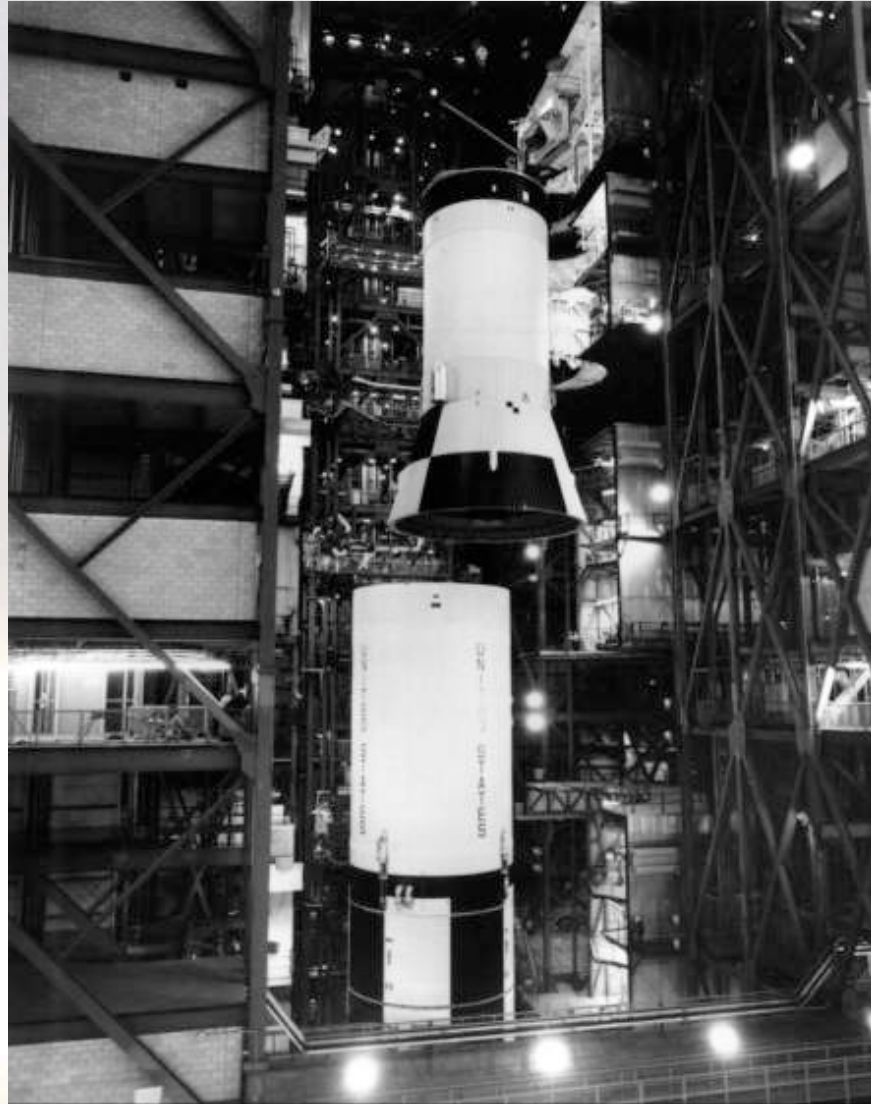

UNIVERSITY OF
MARYLAND

Ground Processing and Launch Facilities
ENAE 791 - Launch and Entry Vehicle Design

S-IVB – Instrument Unit Stacking

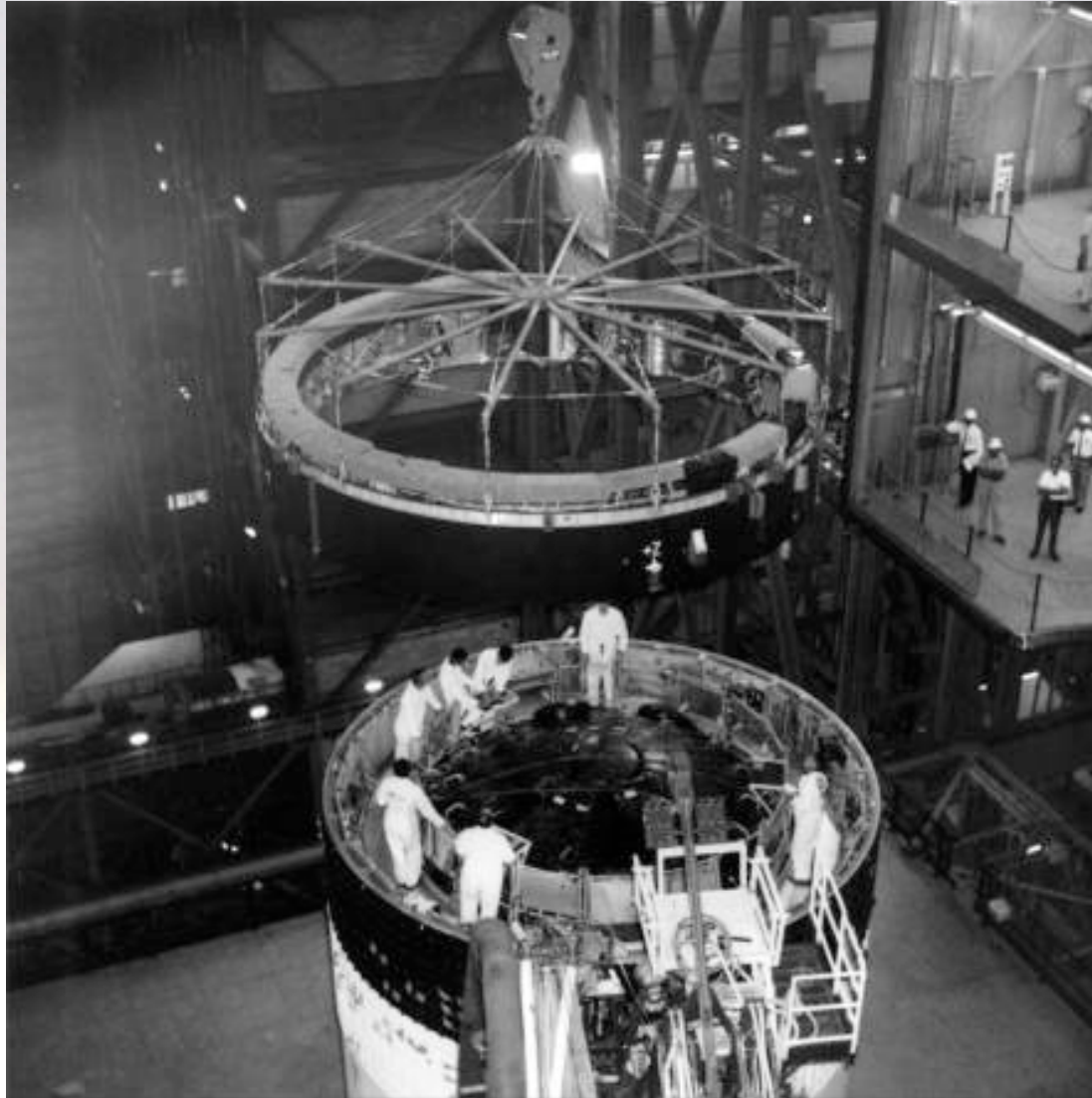

UNIVERSITY OF
MARYLAND

Ground Processing and Launch Facilities
ENAE 791 - Launch and Entry Vehicle Design

IU – Apollo Spacecraft Stacking



UNIVERSITY OF
MARYLAND

Ground Processing and Launch Facilities
ENAE 791 - Launch and Entry Vehicle Design

Apollo–Saturn V Completed Stack in VAB



UNIVERSITY OF
MARYLAND

Ground Processing and Launch Facilities
ENAE 791 - Launch and Entry Vehicle Design

Saturn V Hold-Down Restraints

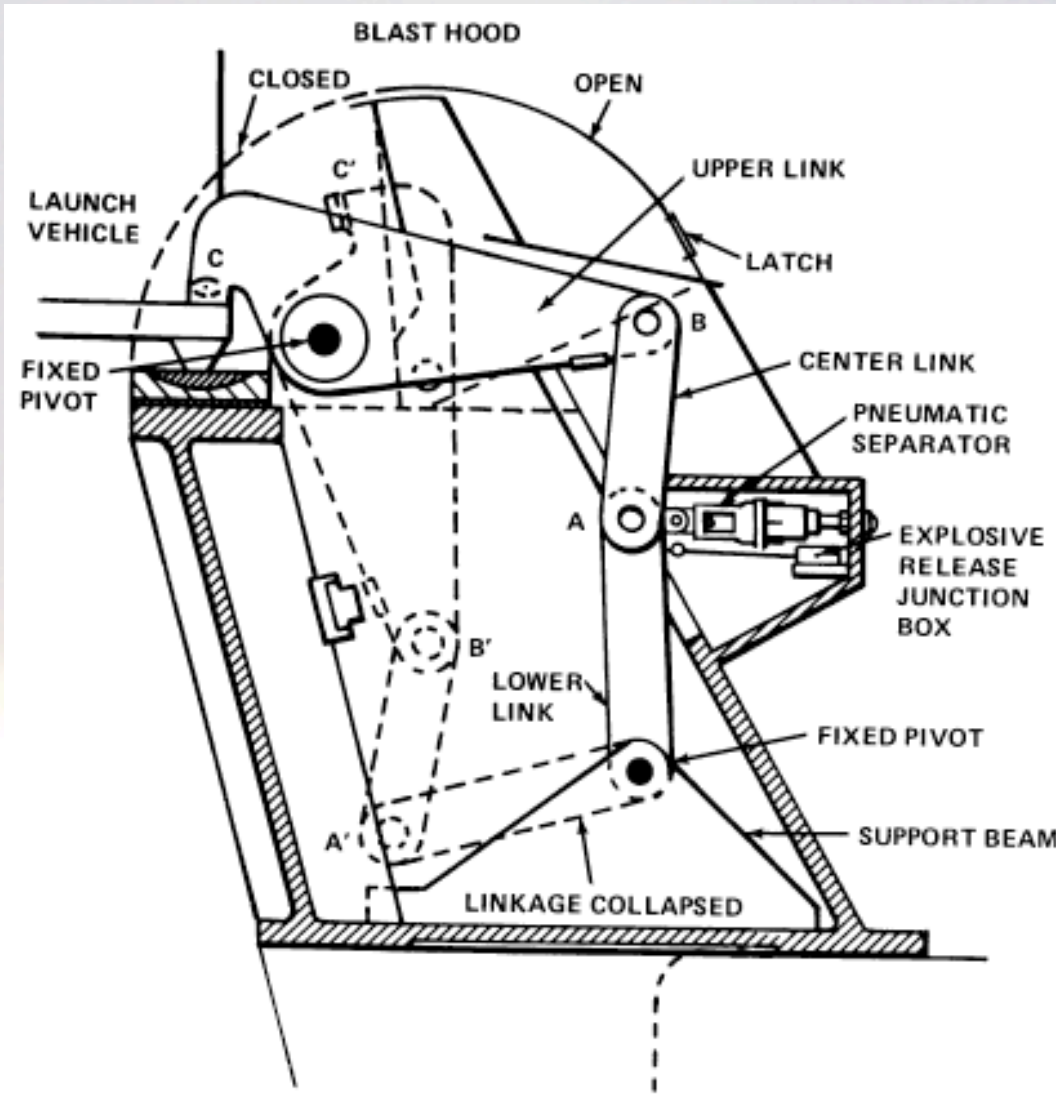

S-1C T-0 Disconnects

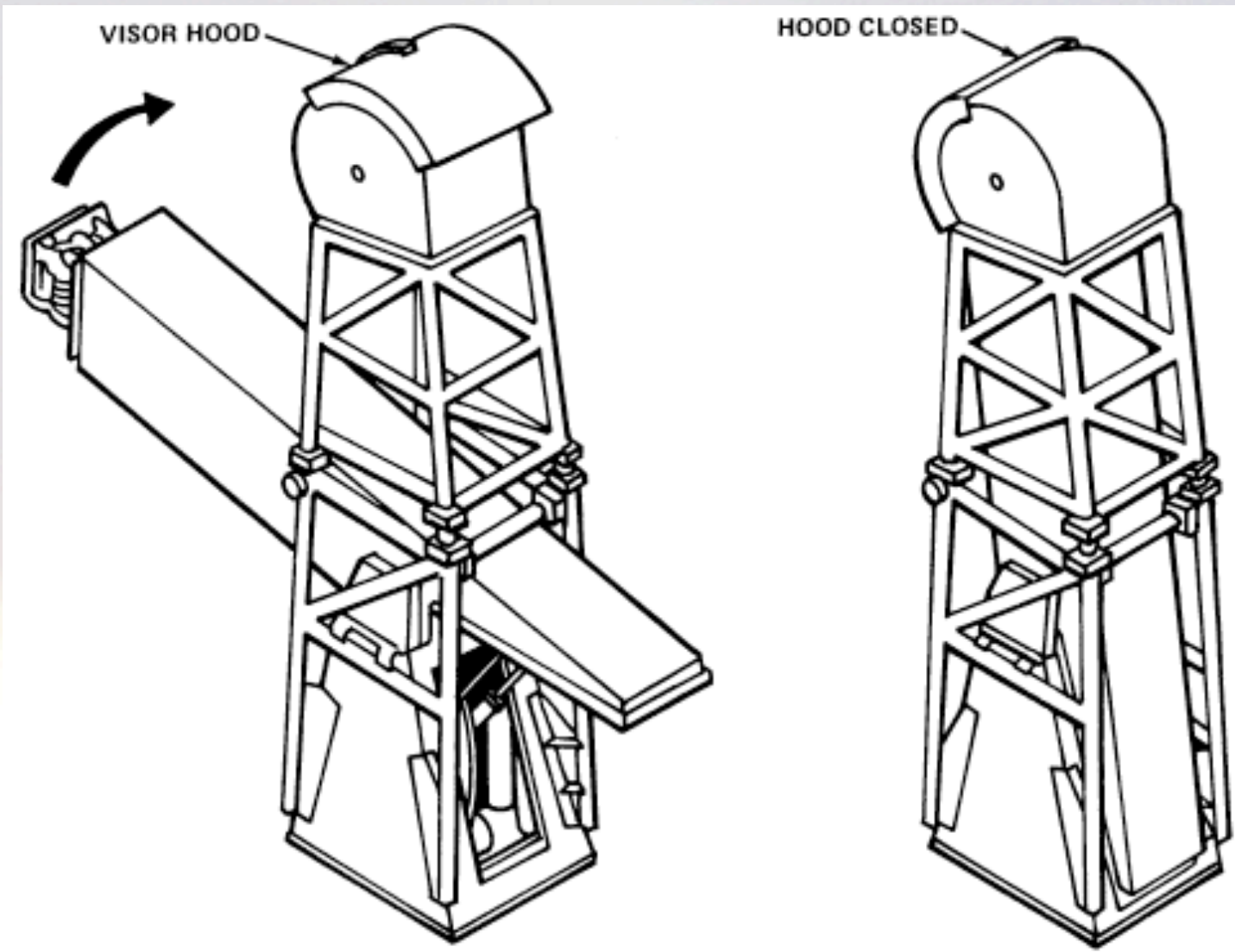

Building the LC-39 Launch Pads



UNIVERSITY OF
MARYLAND

Ground Processing and Launch Facilities
ENAE 791 - Launch and Entry Vehicle Design

LC-39 Crawlerway and Stacks



UNIVERSITY OF
MARYLAND

Ground Processing and Launch Facilities
ENAE 791 - Launch and Entry Vehicle Design

SA-501 at LC-39A

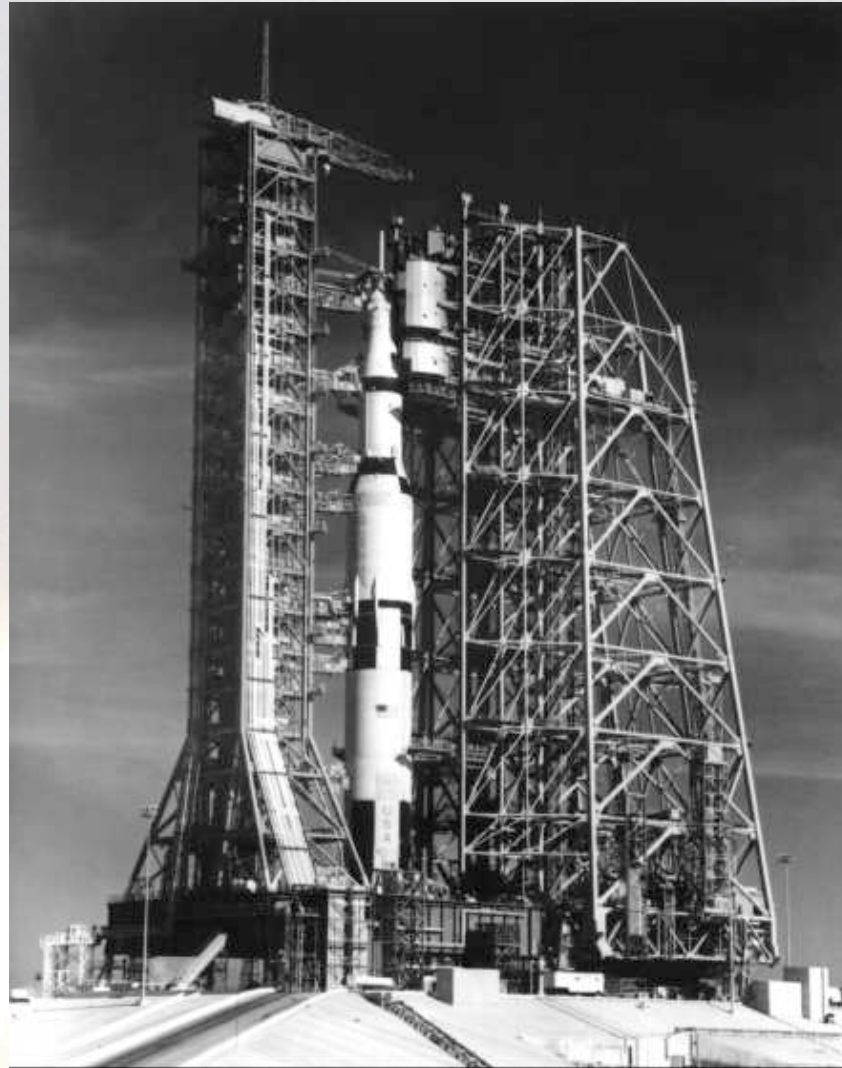

UNIVERSITY OF
MARYLAND

Ground Processing and Launch Facilities
ENAE 791 - Launch and Entry Vehicle Design

LC-39 Mobile Service Structure



UNIVERSITY OF
MARYLAND

Ground Processing and Launch Facilities
ENAE 791 - Launch and Entry Vehicle Design

LC-39 Mobile Service Structure

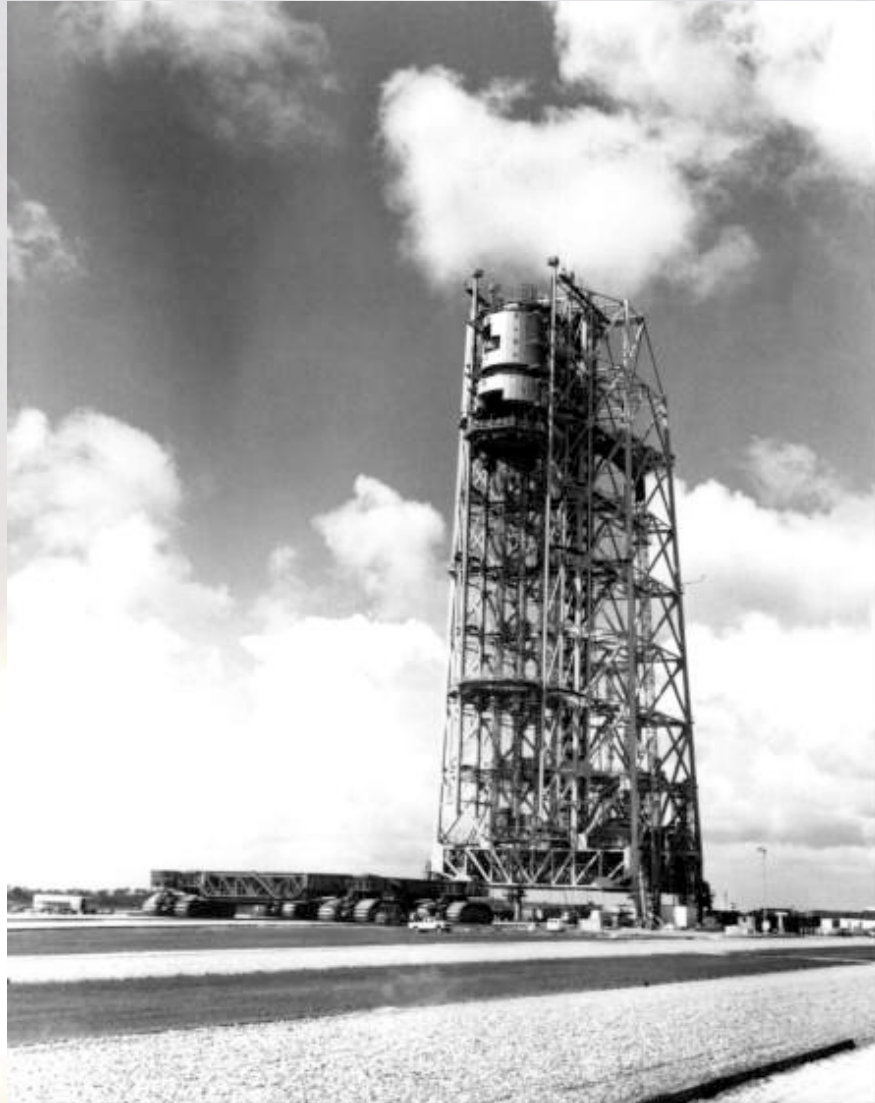

UNIVERSITY OF
MARYLAND

Ground Processing and Launch Facilities
ENAE 791 - Launch and Entry Vehicle Design

Complex 39 Launch Mounts

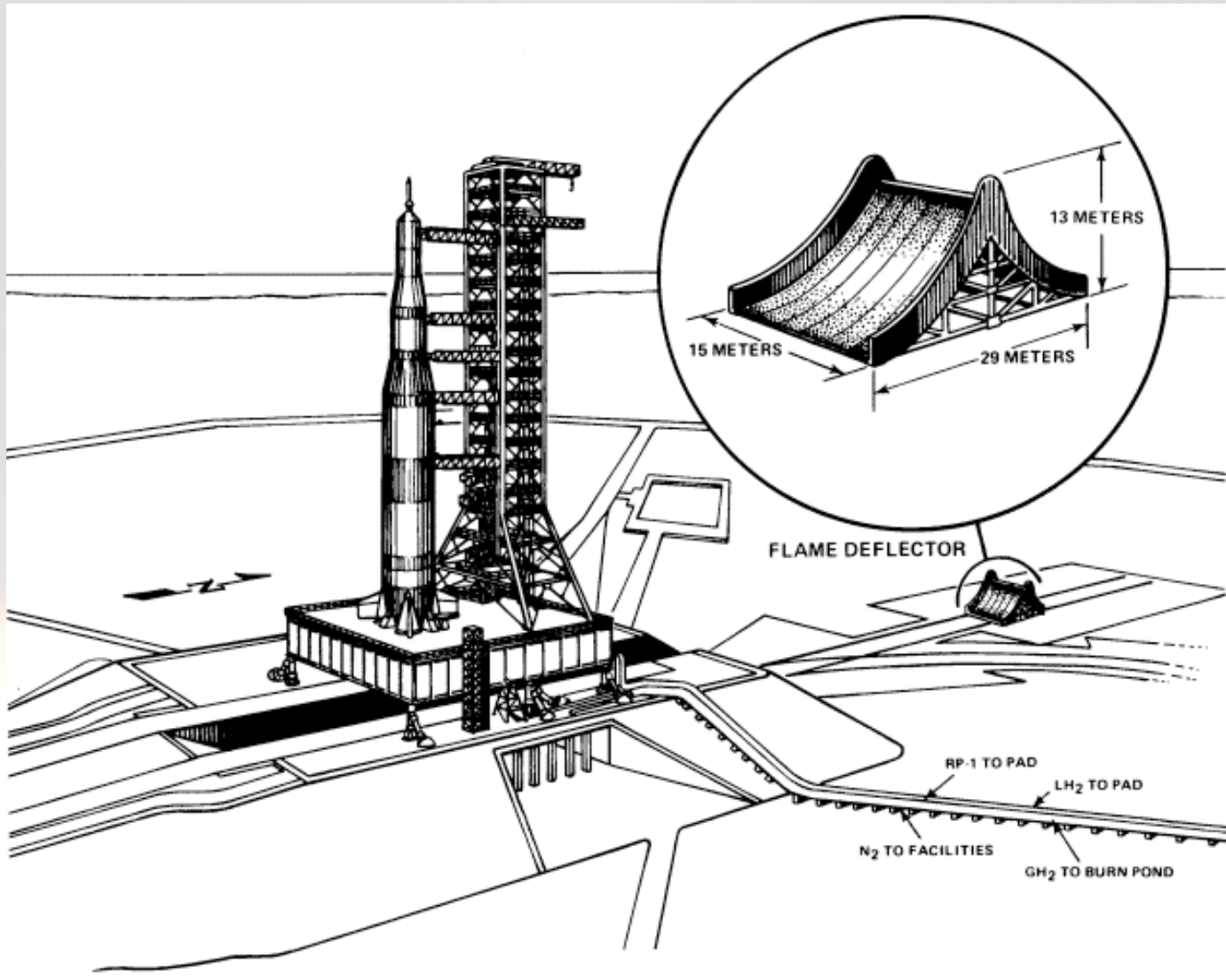

Expenditures for LC-39

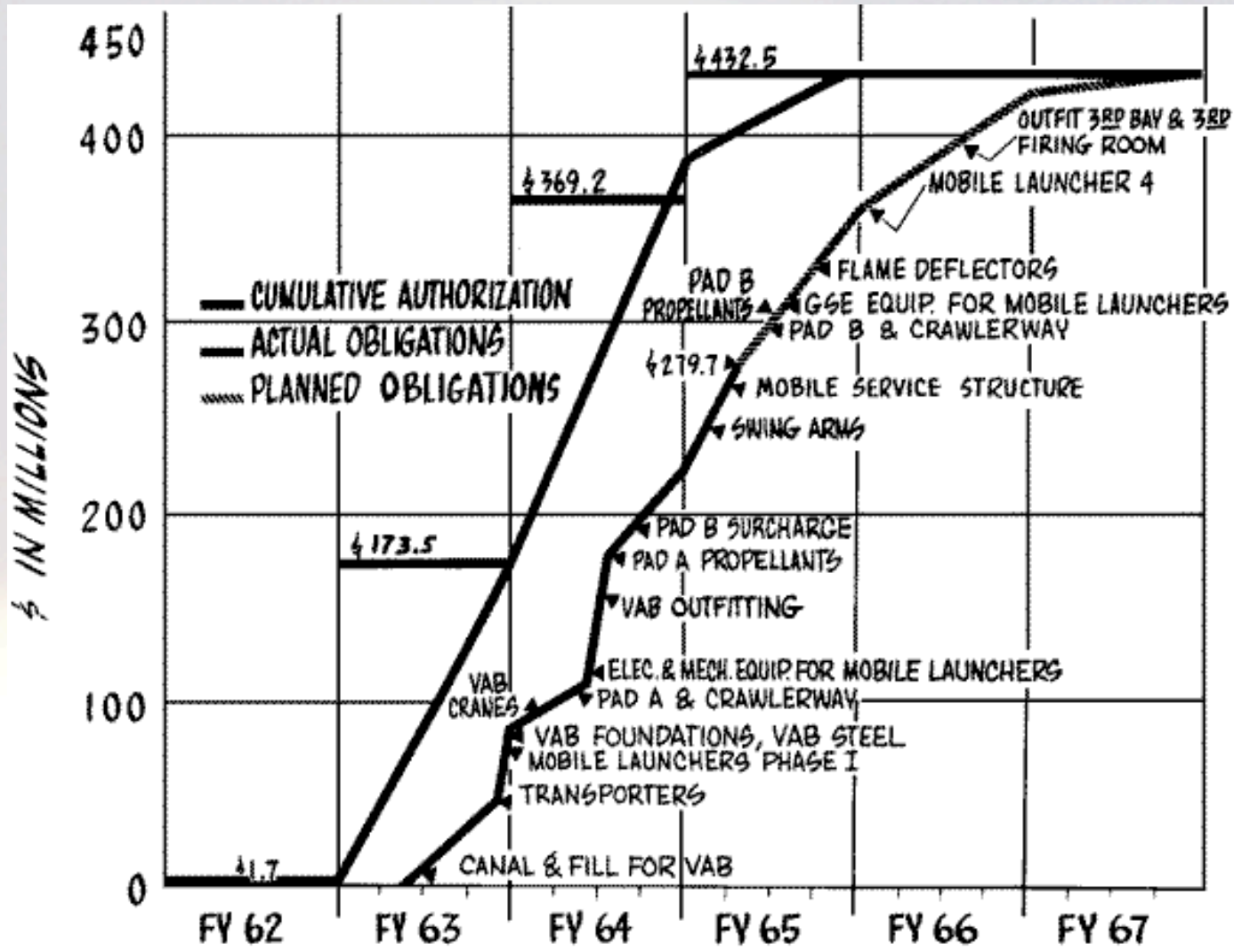

Saturn V Vehicle Checkout Flow

SATURN V CHECKOUT SCHEDULE MILESTONES

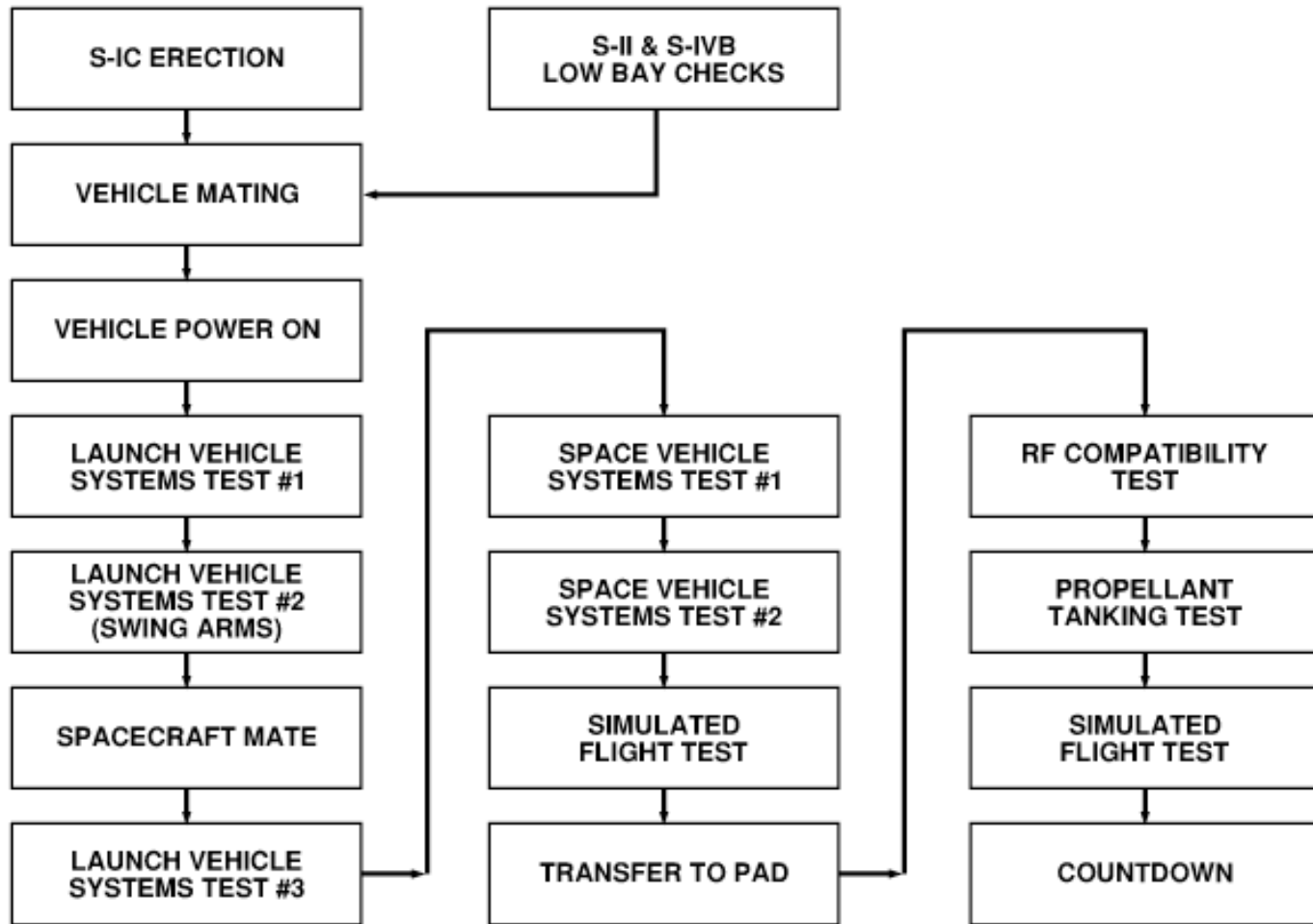

Soyuz Launch Vehicle Moving to Pad



Soyuz Launch Site



Energia in Horizontal Integration

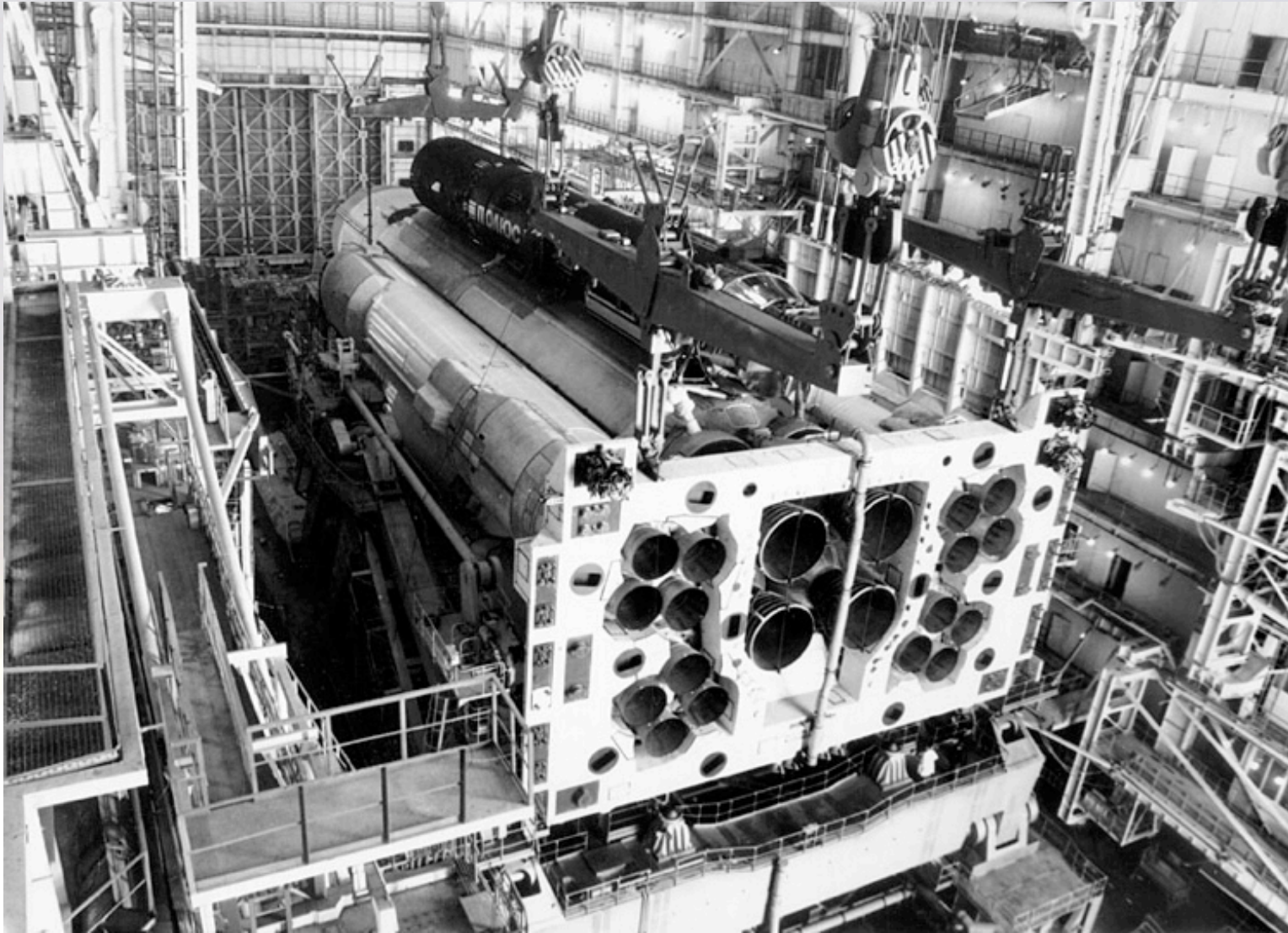

Energia Transported to Pad



Energia at Pad



Energia Erection

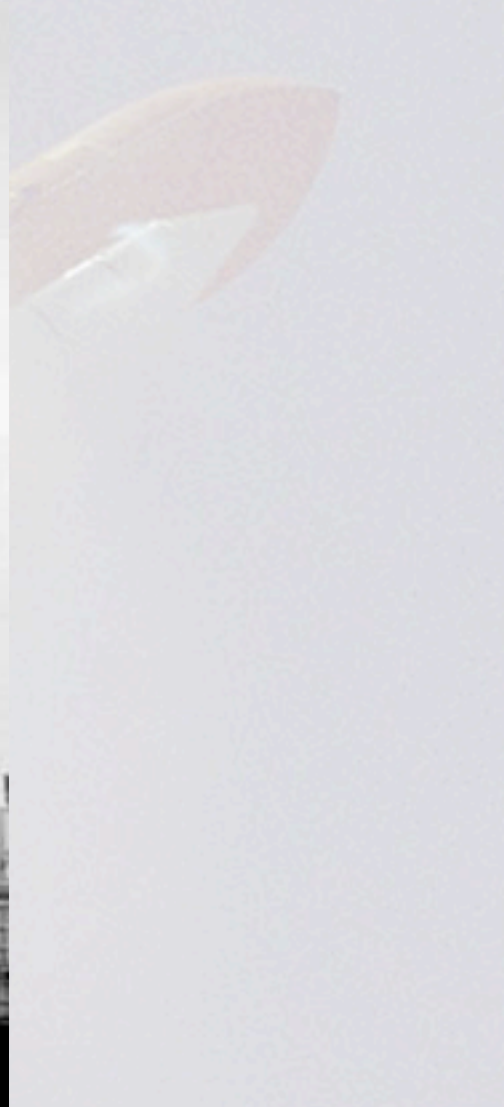

Energia on Pad

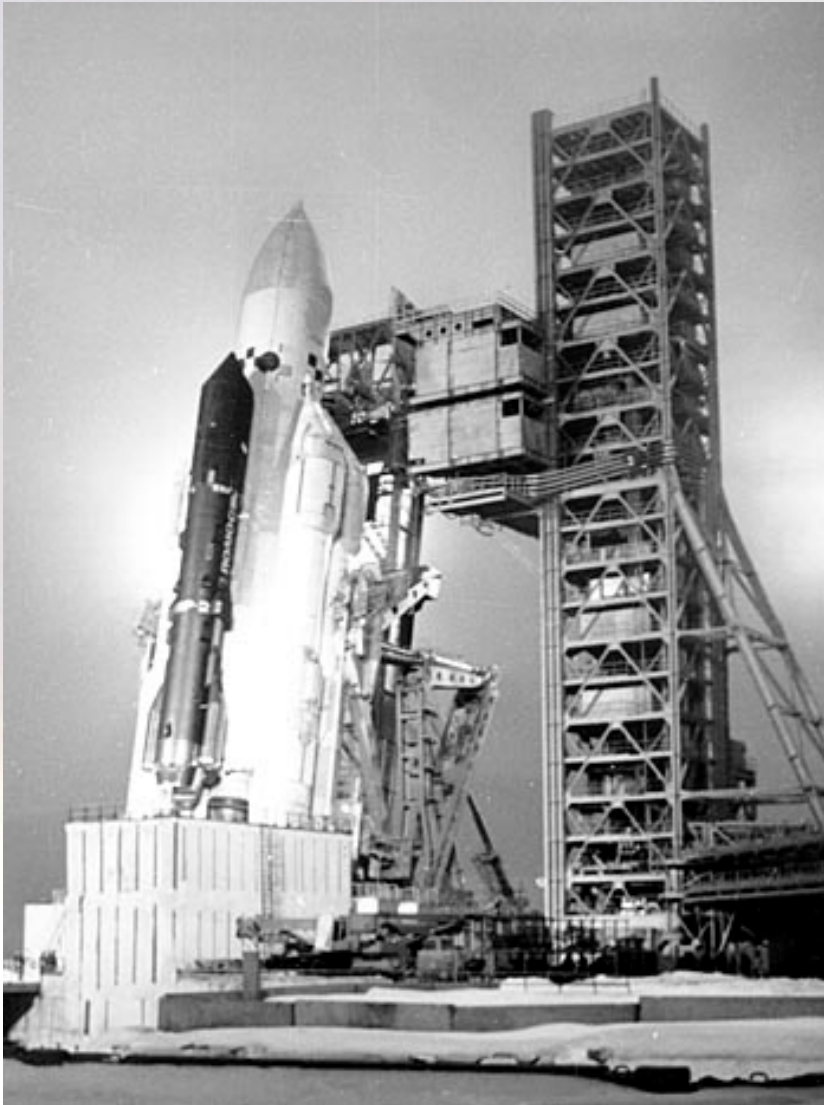

Shuttle Landing Facility



Transport to Orbiter Processing Facility



Payload Bay Inspection in OPF



SSME Removal/Installation



Transfer to Vehicle Assembly Building



Attaching Hoisting Fixtures



Attaching Orbiter to Shuttle Stack



Shuttle Rollout



Delta IV Heavy Horizontal Integration



Delta IVH Horizontal Integration Facility



Delta IV Heavy Transporter



UNIVERSITY OF
MARYLAND

Ground Processing and Launch Facilities
ENAE 791 - Launch and Entry Vehicle Design

Delta IV Heavy at LC34 Blockhouse



Delta IV Heavy Arrives at LC-34



UNIVERSITY OF
MARYLAND

Ground Processing and Launch Facilities
ENAE 791 - Launch and Entry Vehicle Design

Delta IV Heavy Module Interconnects



UNIVERSITY OF
MARYLAND

Ground Processing and Launch Facilities
ENAE 791 - Launch and Entry Vehicle Design

Delta IV Heavy at Pad



UNIVERSITY OF
MARYLAND

Ground Processing and Launch Facilities
ENAE 791 - Launch and Entry Vehicle Design

Delta IV Heavy Rotation



UNIVERSITY OF
MARYLAND

Ground Processing and Launch Facilities
ENAE 791 - Launch and Entry Vehicle Design

Delta IV Heavy Rotation



UNIVERSITY OF
MARYLAND

Ground Processing and Launch Facilities
ENAE 791 - Launch and Entry Vehicle Design

Delta IV Heavy at Pad



DC-XA on Launch Pad

