

Project **SCOUT**

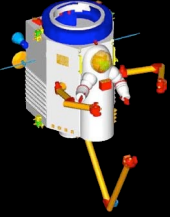

SCOUT

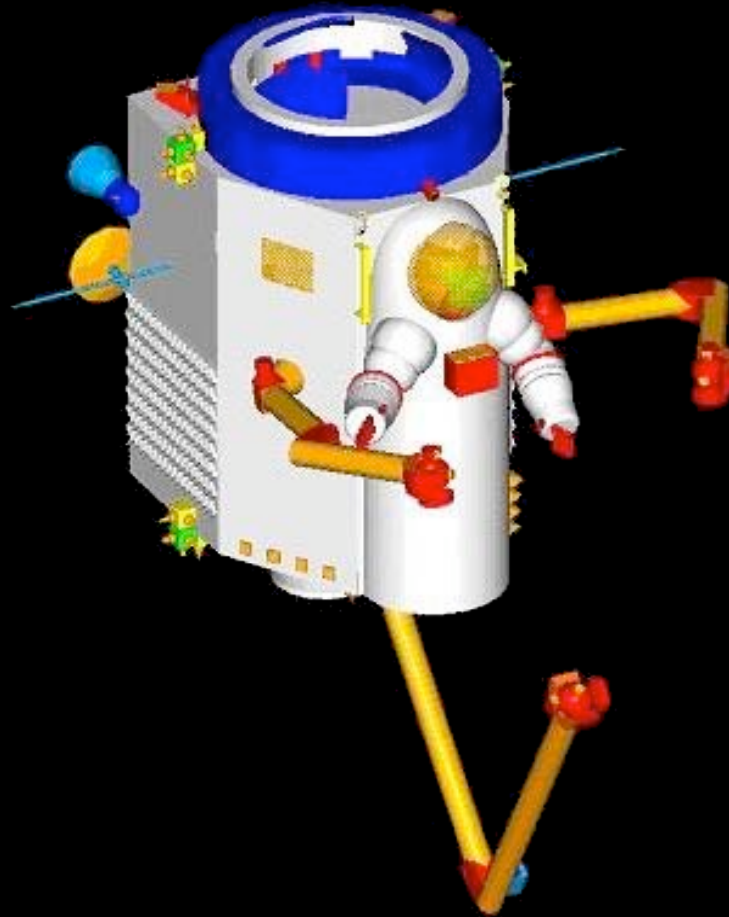

Project **SCOUT**

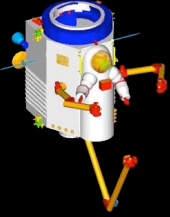

SCOUT

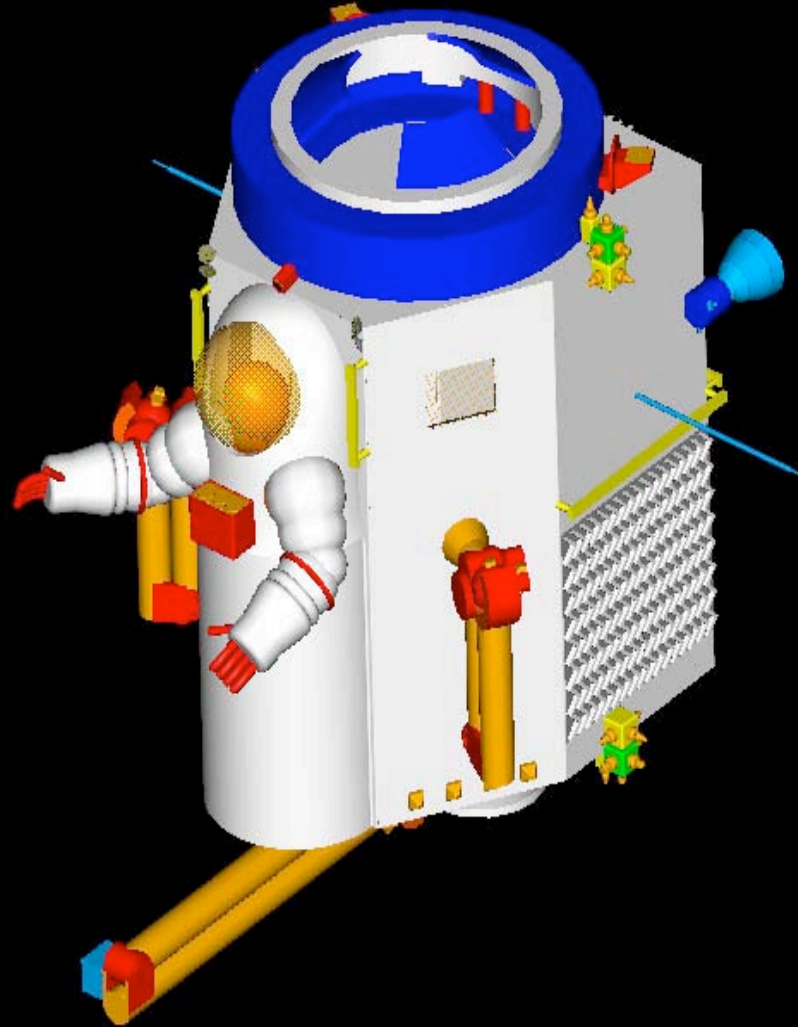

Project **SCOUT**

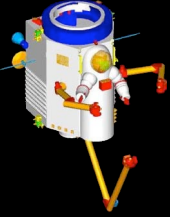

SCOUT

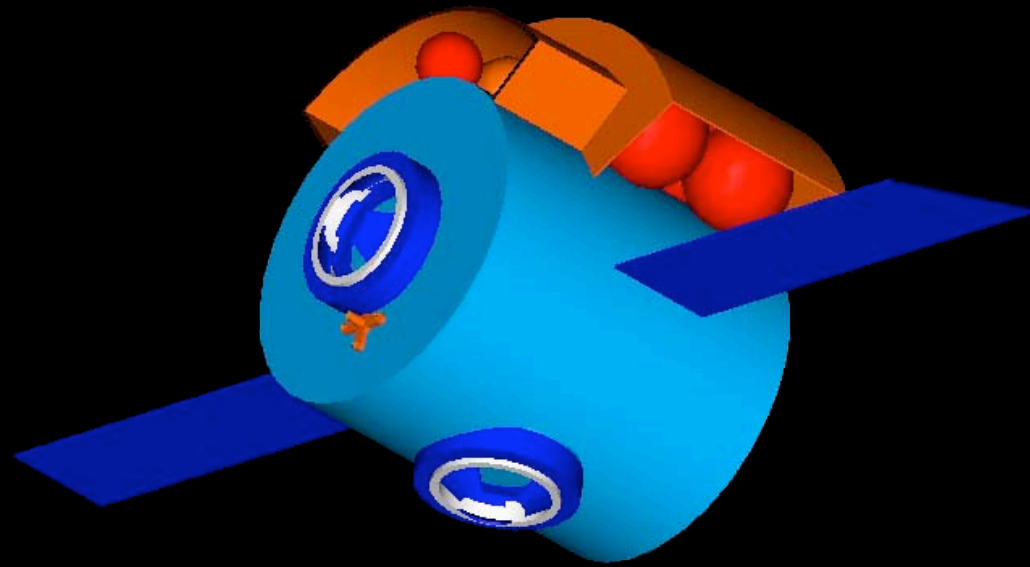

Project **SCOUT**

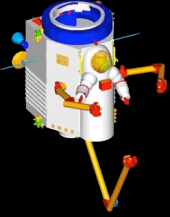

SCOUT

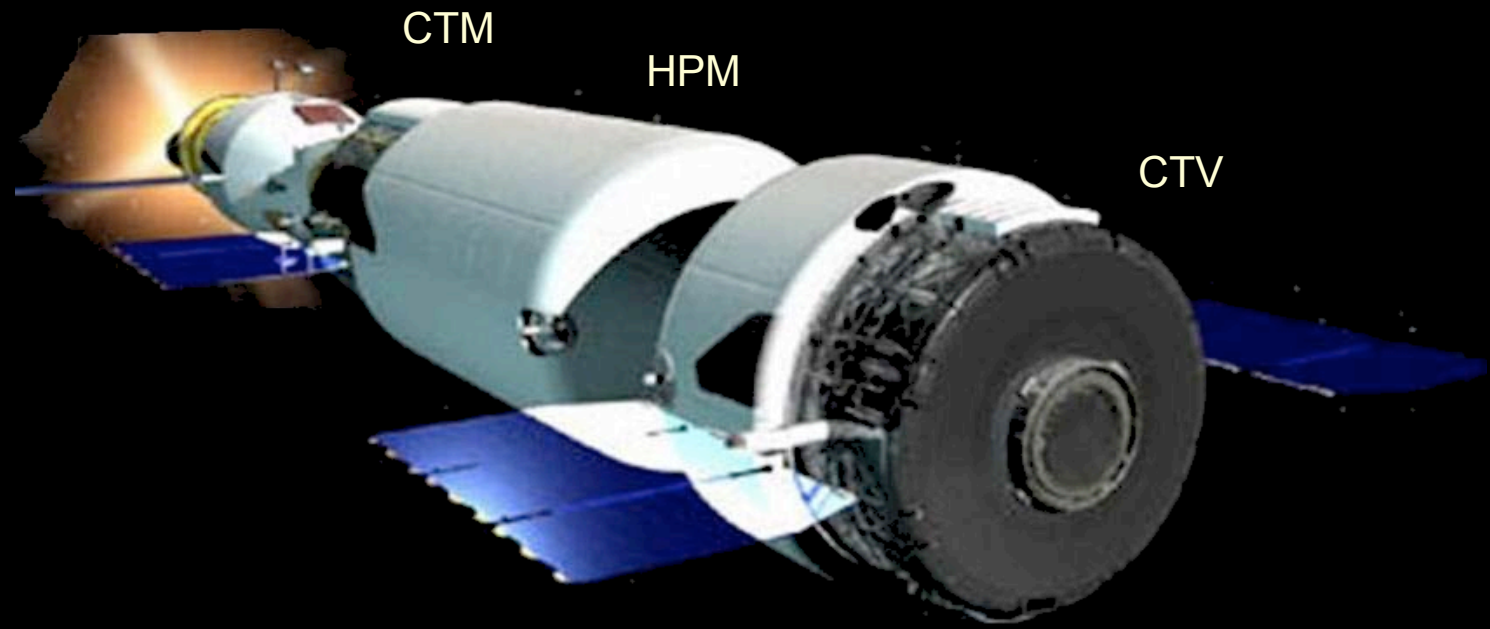

Lin, Frank Lunar L1 Gateway & SEP Design Briefing.

University of Maryland
Space Systems Design



Project **SCOUT**



SCOUT

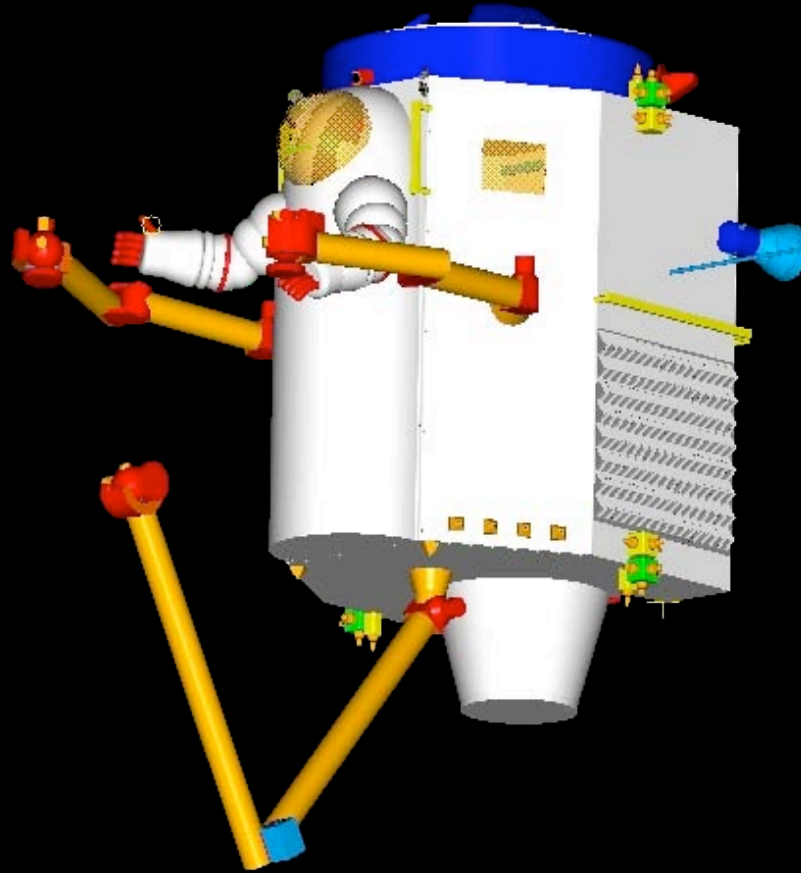

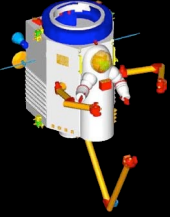

SCOUT

N_2 (Gas) Tanks

N_2H_4 Tanks

Video
Guidance
System

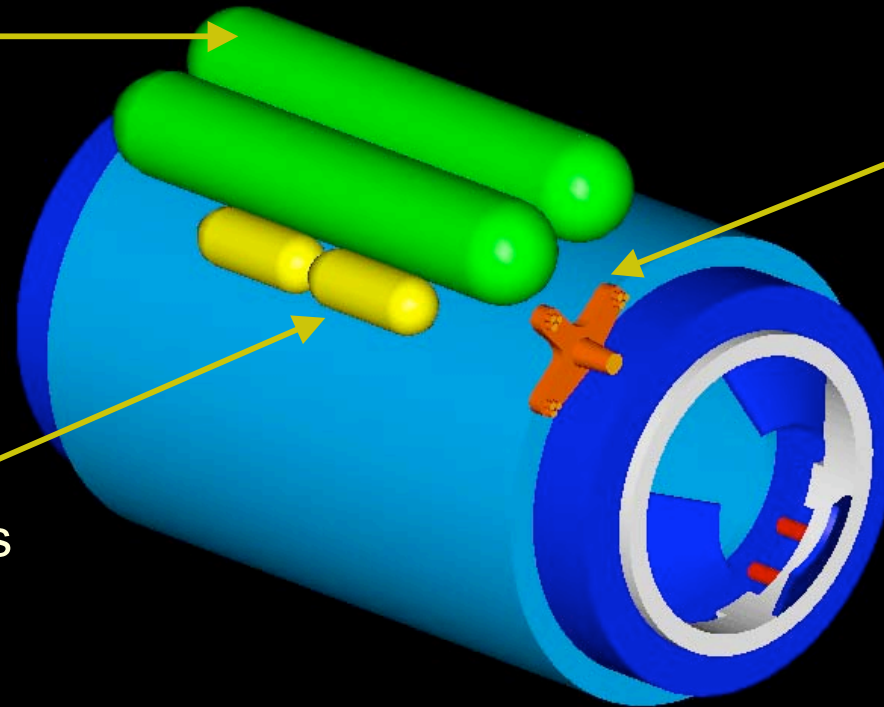

Project **SCOUT**



SCOUT

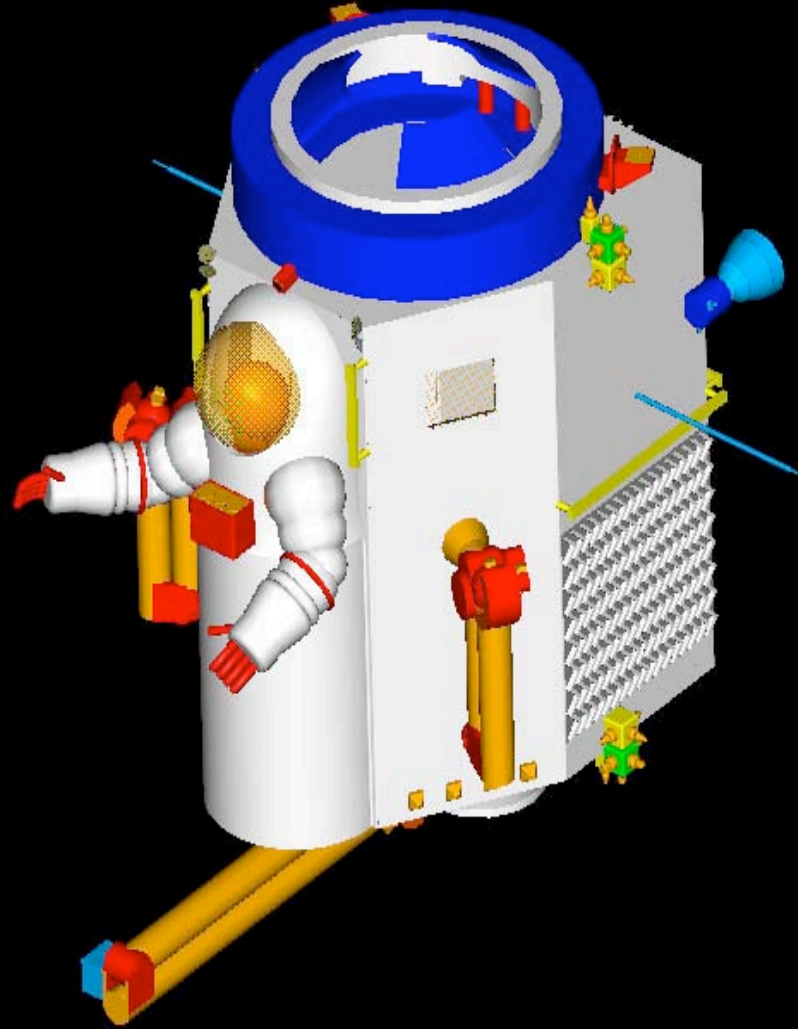



Task Arm:

shoulder roll
shoulder pitch
elbow roll

elbow pitch
wrist roll

wrist pitch
wrist yaw
tool drive roll

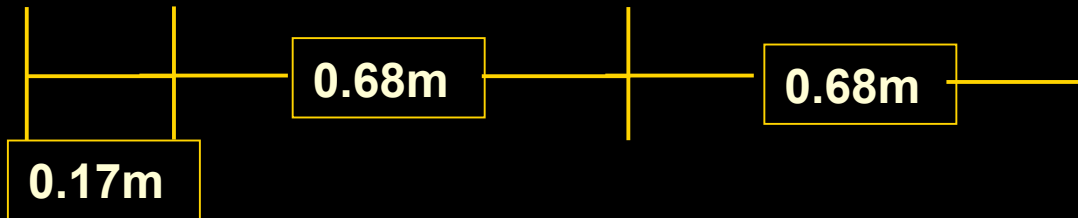
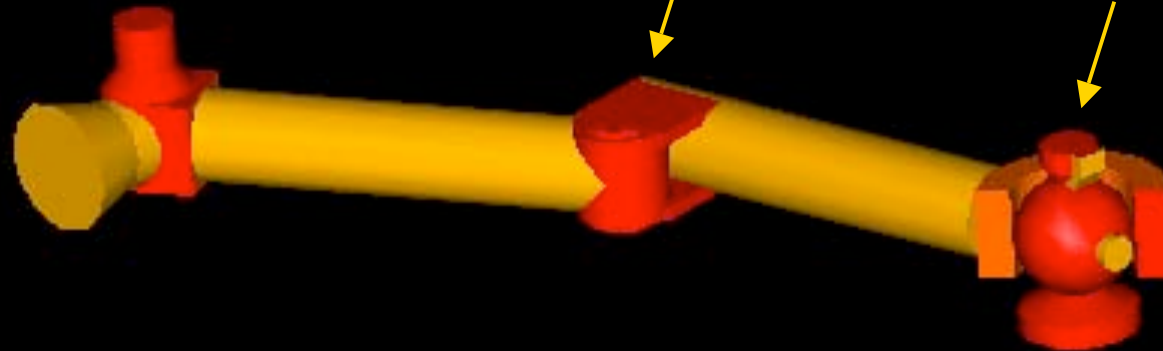

SCOUT



Grapple Arm:

SCOUT

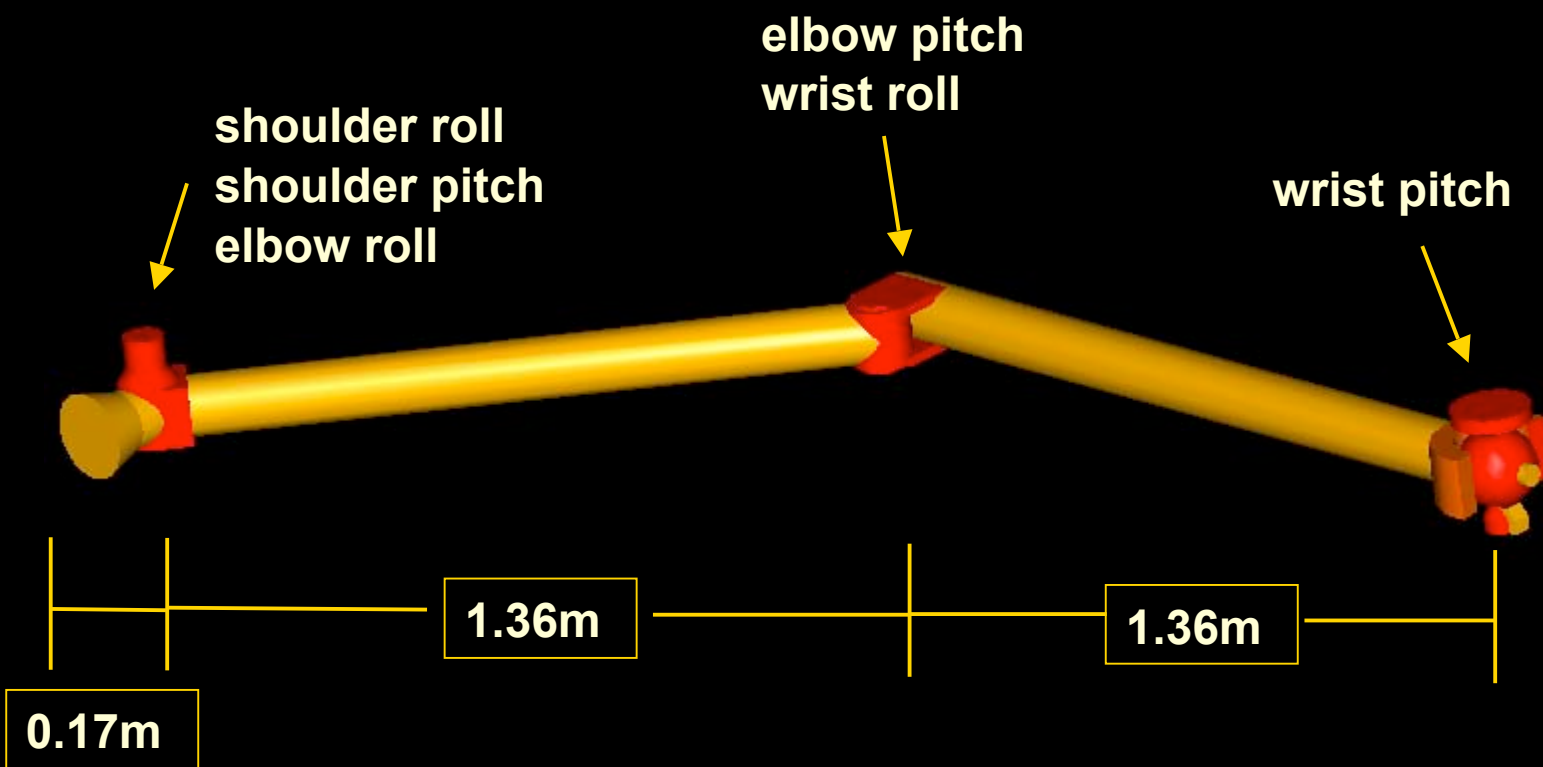

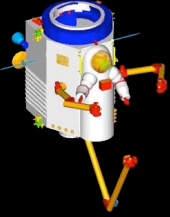

SCOUT

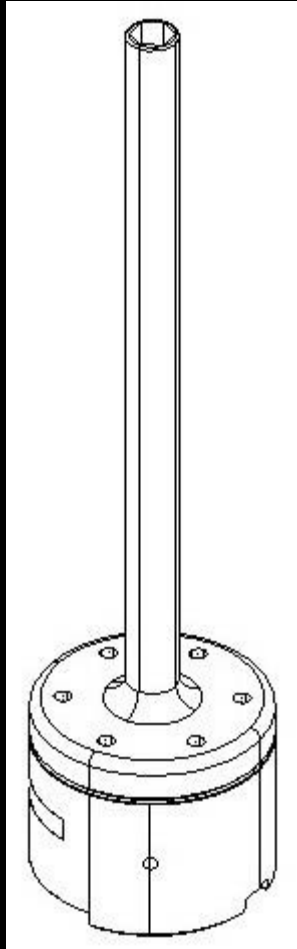

Bare Bolt Drive

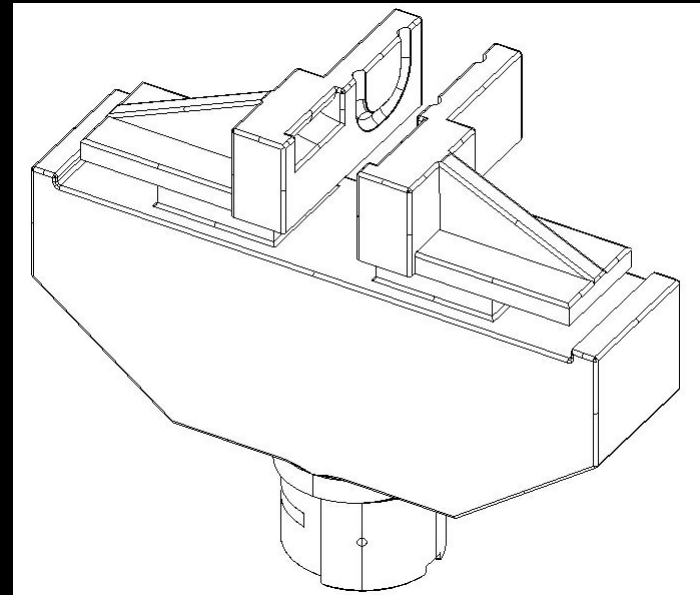

Parallel Jaw Mechanism

<http://rtsx.ssl.umd.edu>



Project **SCOUT**

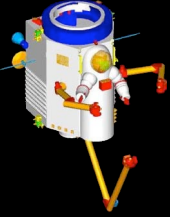

SCOUT

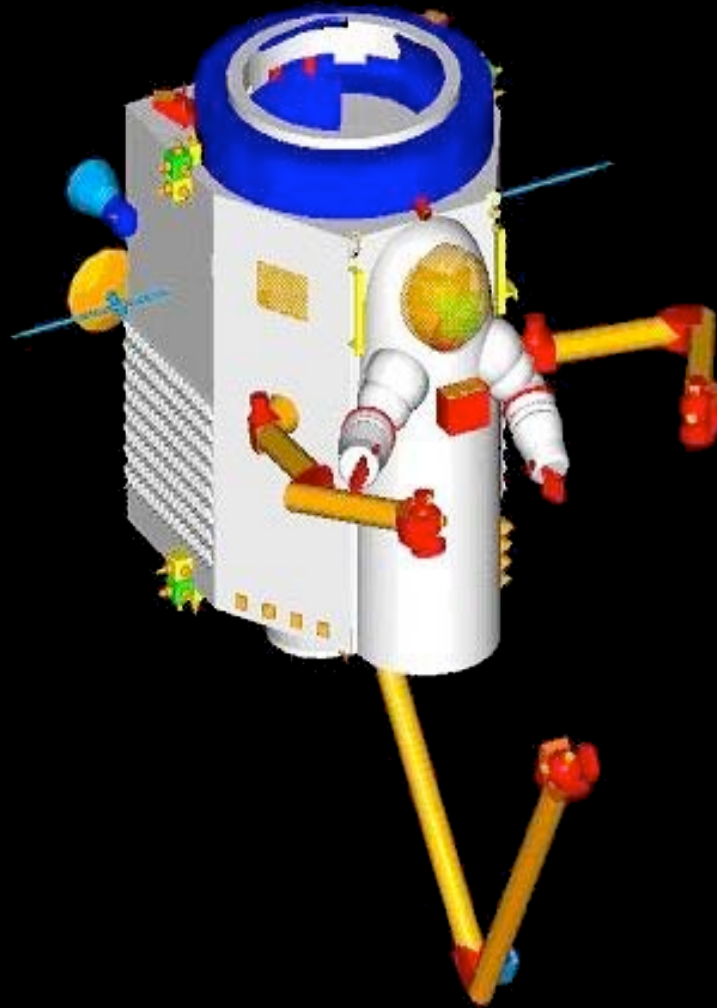

Project SCOUT

Unregistered HyperCam

SCOUT

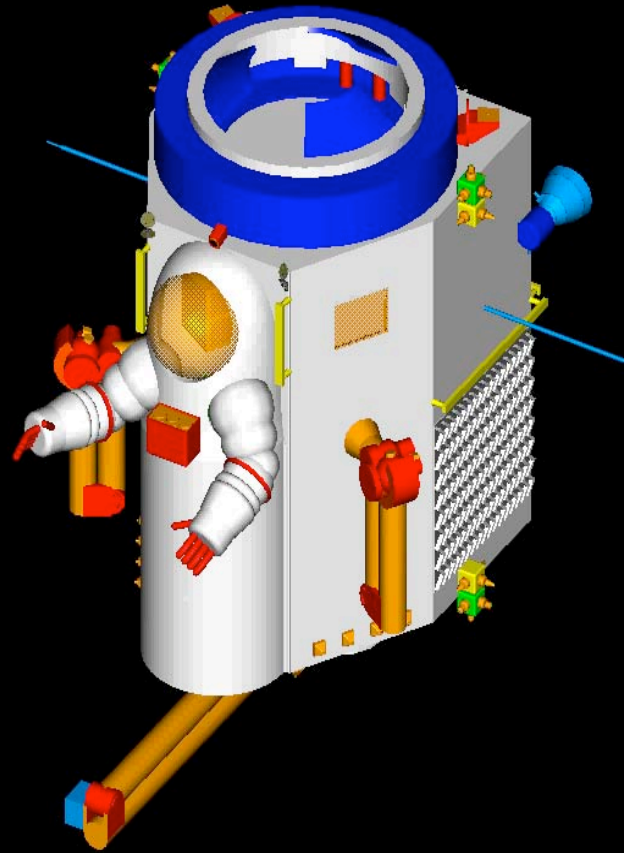

Project **SCOUT**



SCOUT

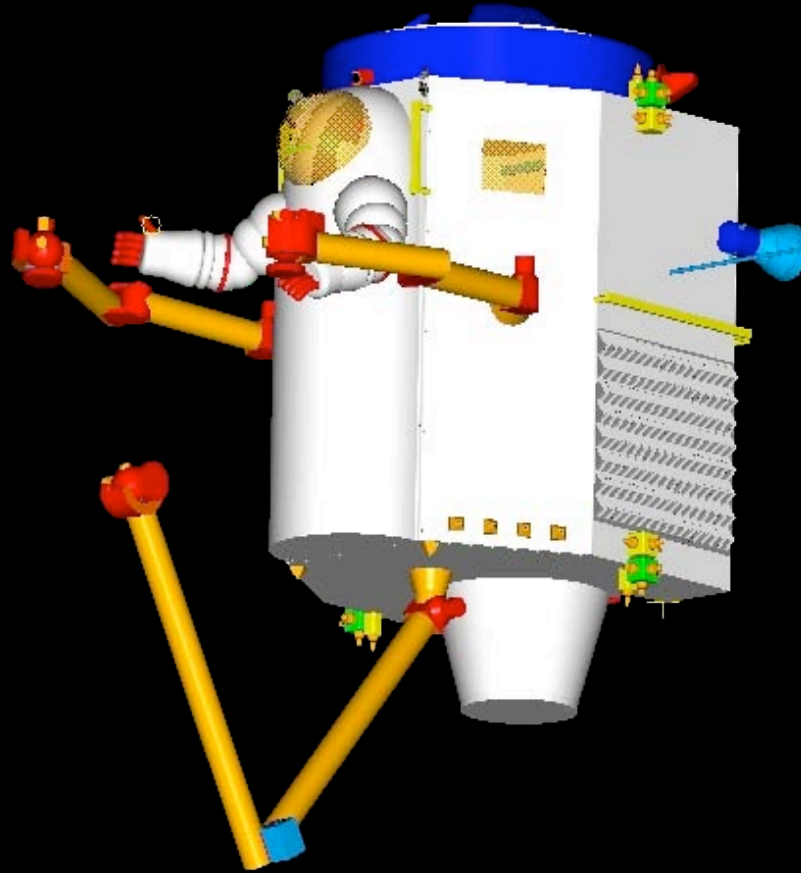

Project **SCOUT**

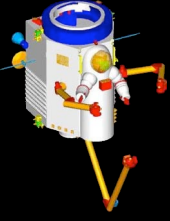

SCOUT

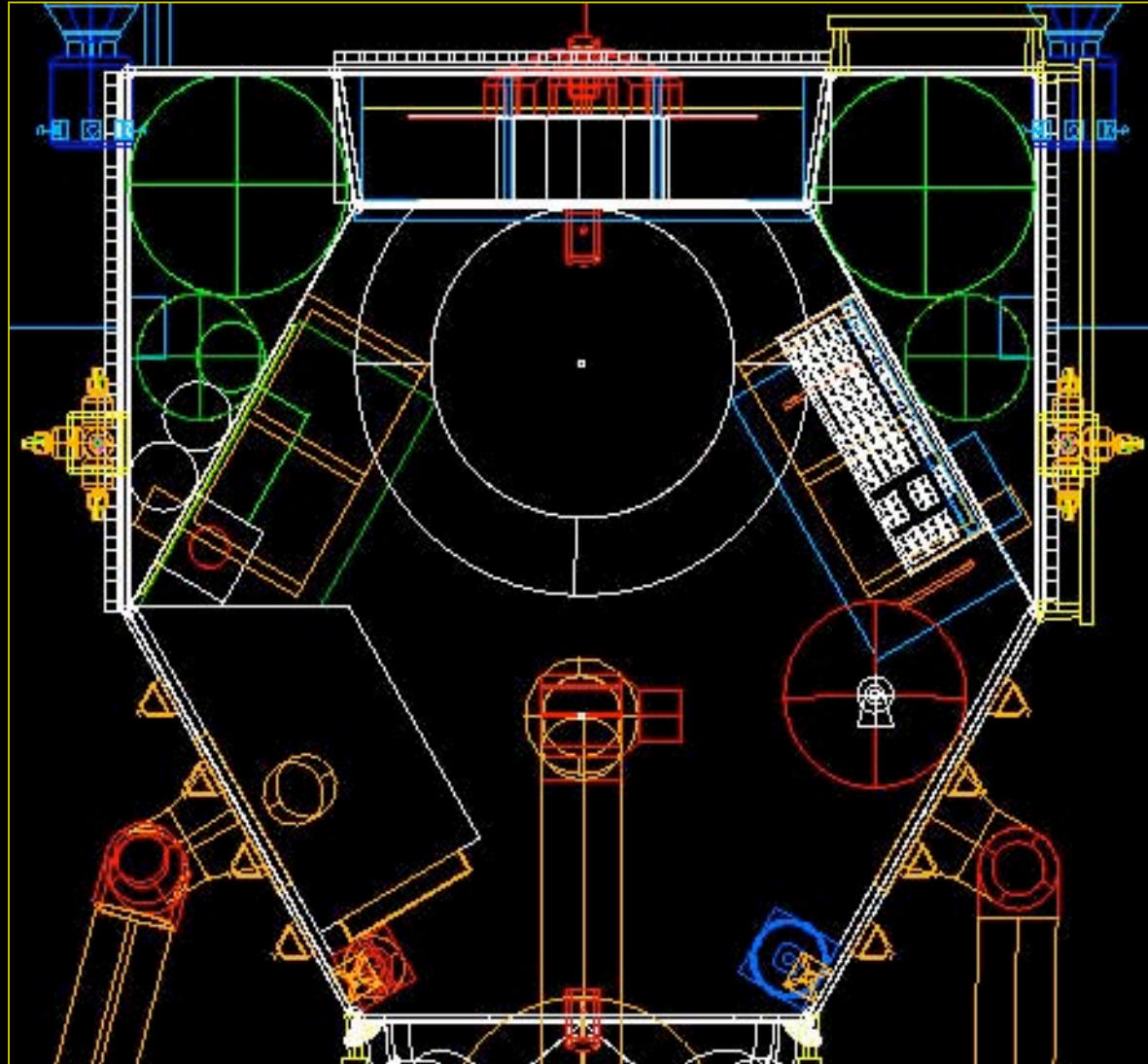

Project **SCOUT**



SCOUT

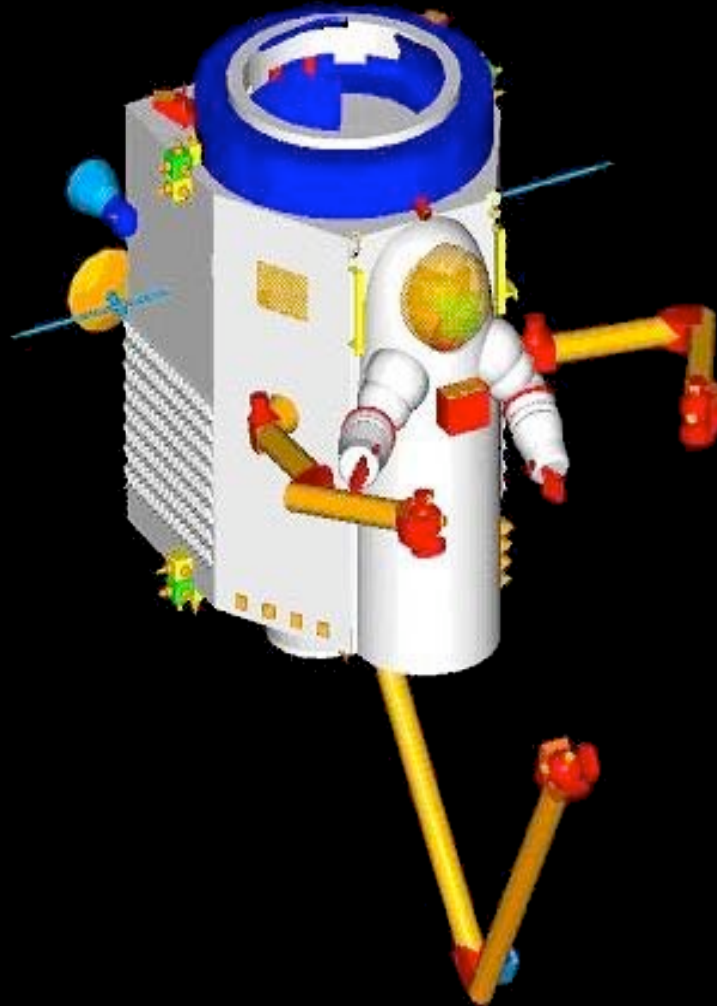

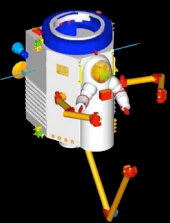

SCOUT

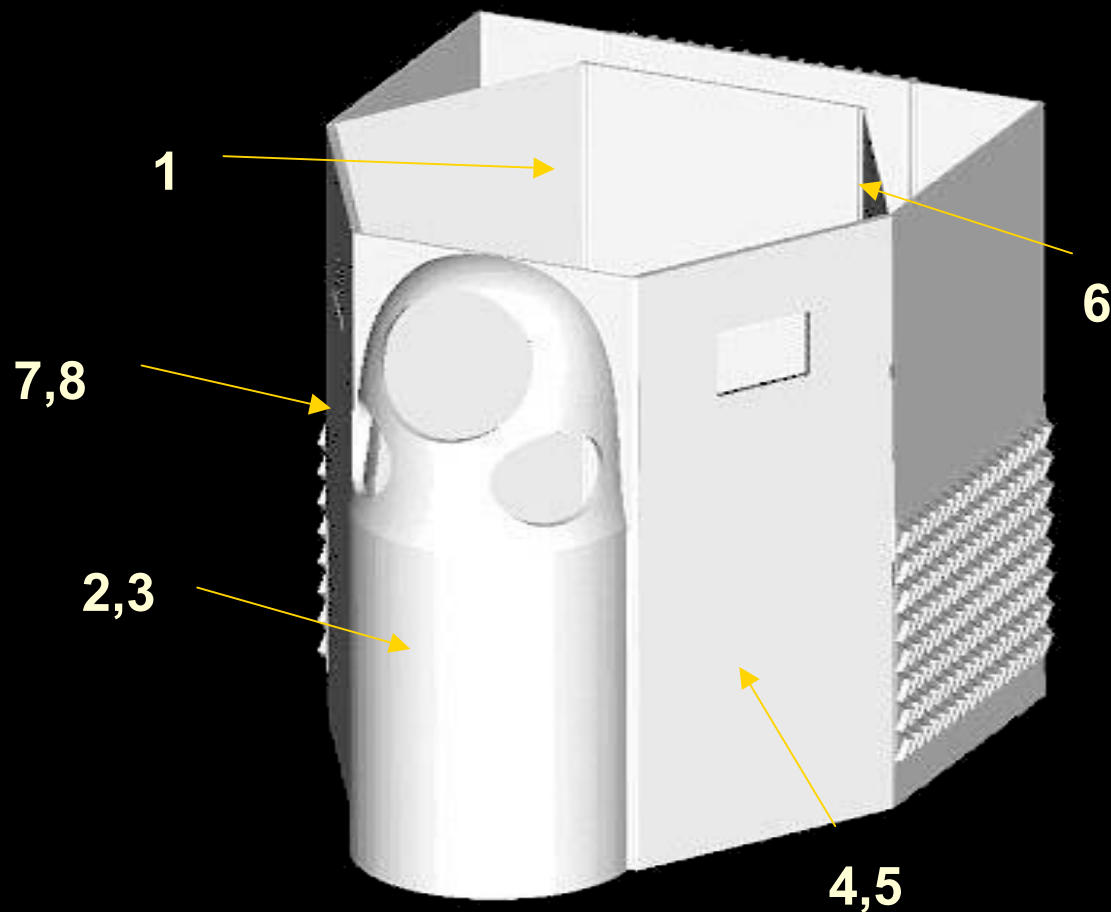

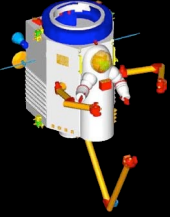

SCOUT

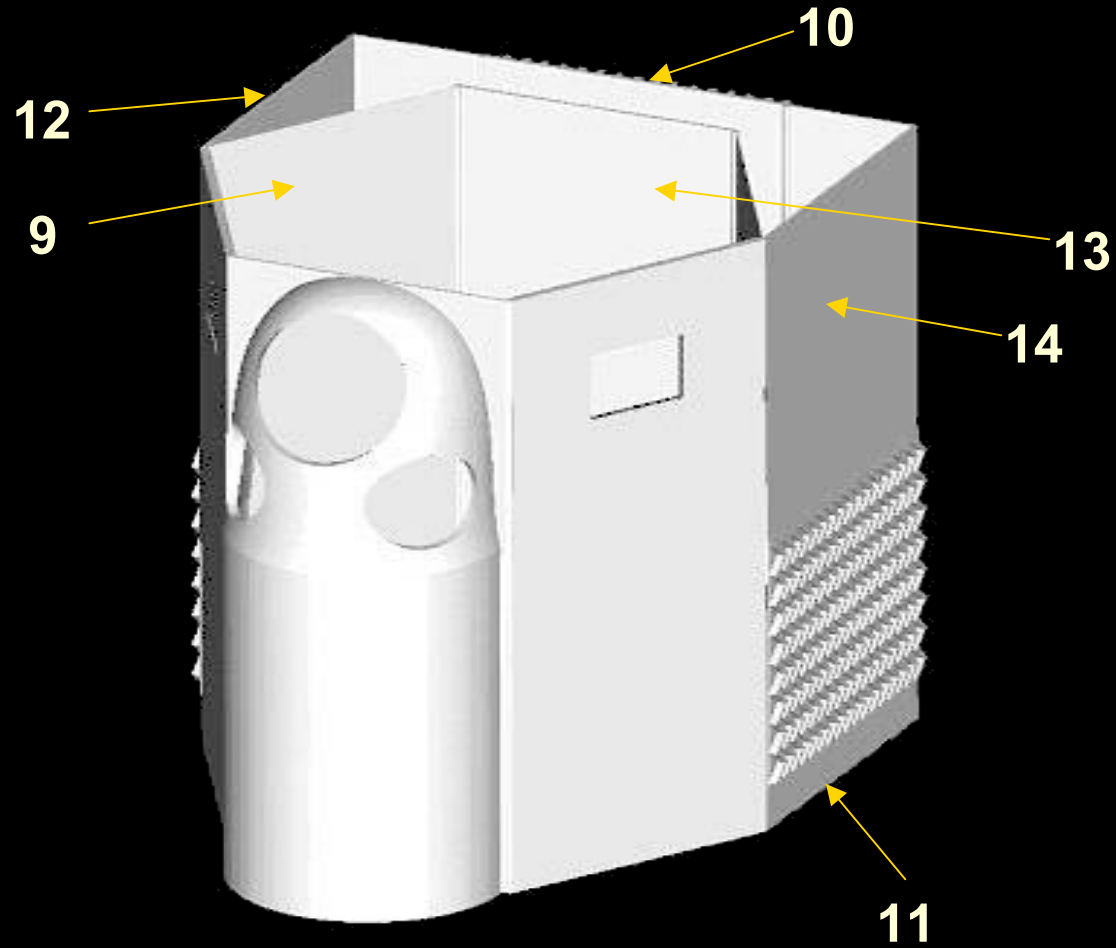

Project **SCOUT**

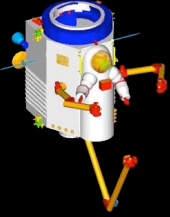

SCOUT

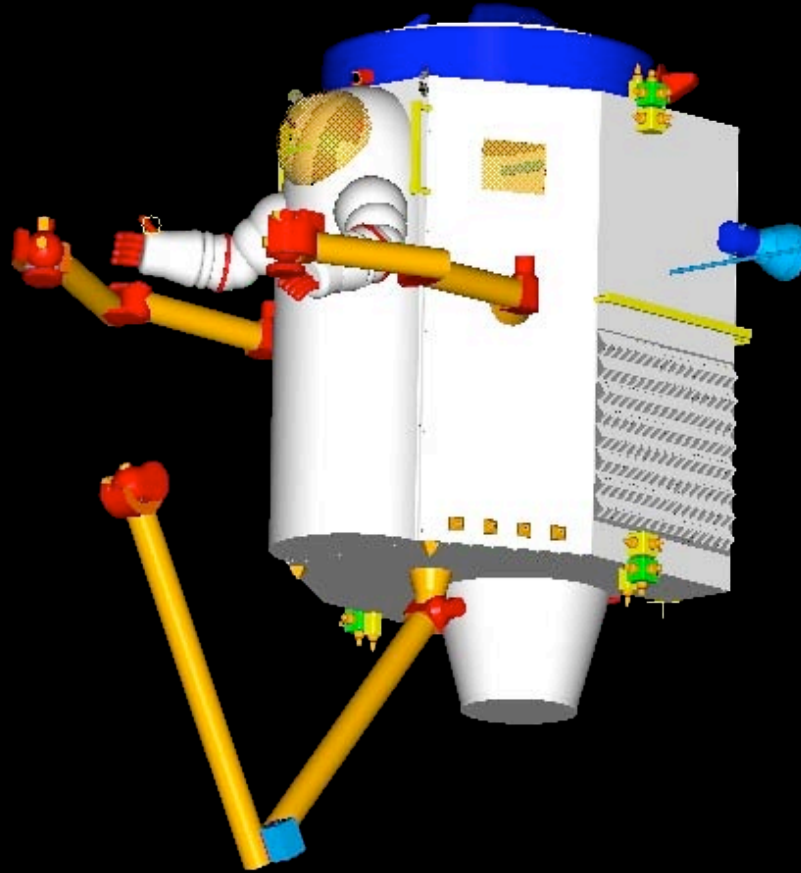

Nitrogen System Schematic

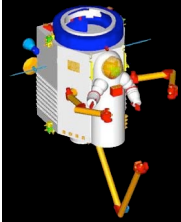

SCOUT

- Fill and Drain Valve
- Flow Control Valve Normally Closed
- Flow Control Valve Normally Open
- Filter
- Thrust Chamber Valve (TCV)
- Valve Branch A
- Valve Branch B
- Heater
- Pressure
- Temperature
- Thruster
- Isolation Valve
- Pressure Regulator
- Relief Valve

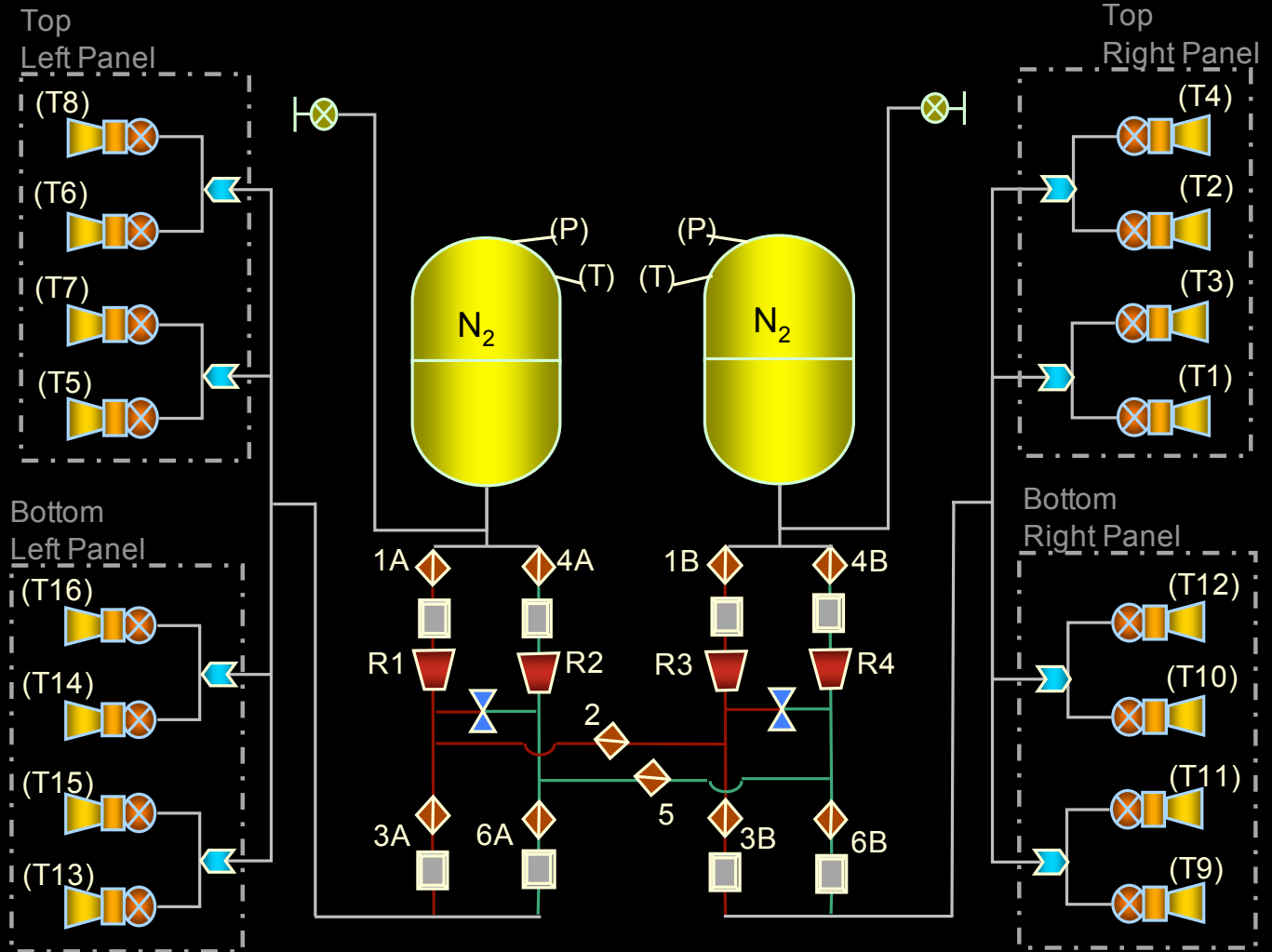

Project SCOUT

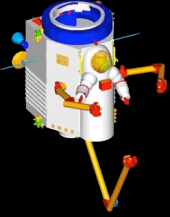

SCOUT

- Located near Power Distribution Units (PDUs)
- Accessible via EVA to fix/replace:
 - 1 spare stored in docking module
 - 3 batteries replaced once a year

EVA handrails

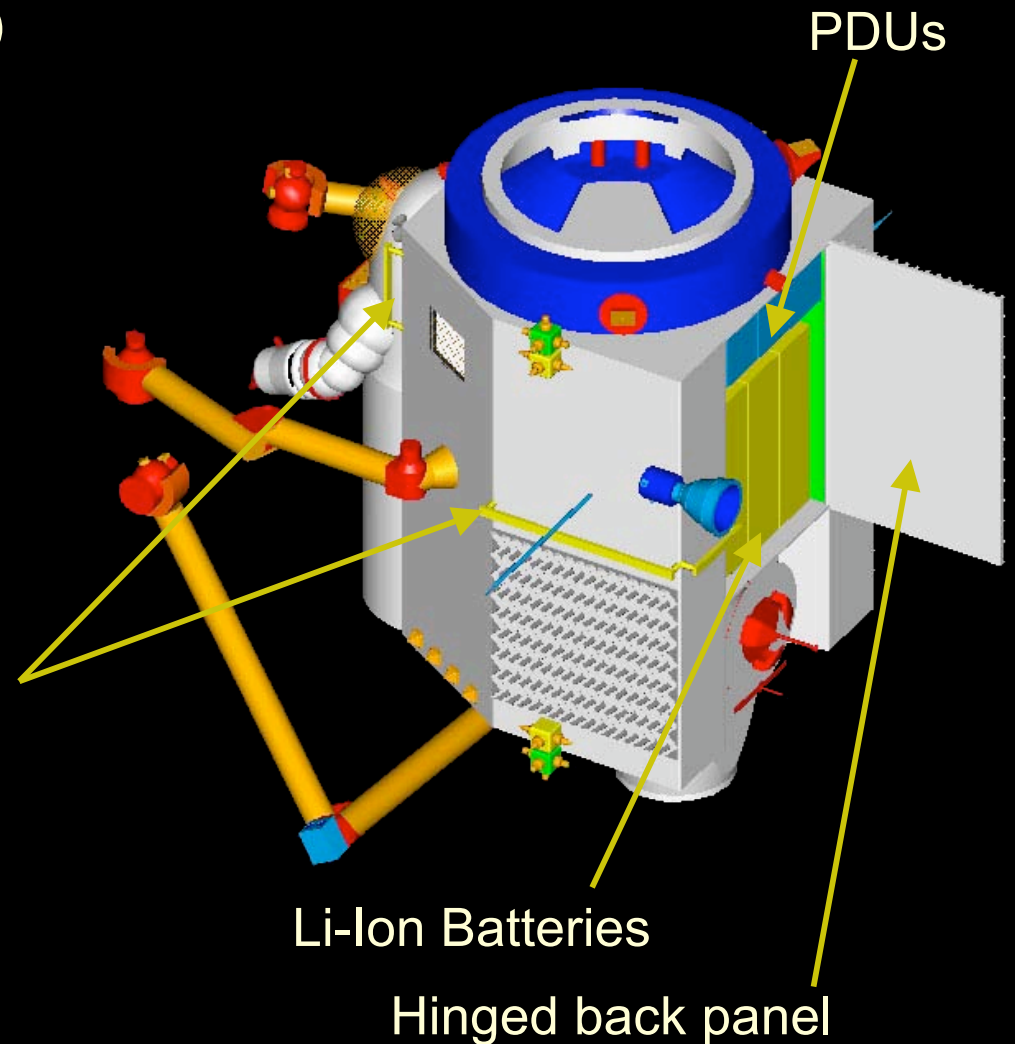

Project SCOUT



SCOUT

- Components on CompactPCI bus interface:
 - Computer subsystem
 - Three identical Flight & Data Control Computers
 - Each will be a single-board RAD750 computer
 - Data bus interface (I/O)
 - Two redundant Firewire (IEEE 1394) interface cards
 - Mass memory storage
 - Two identical solid state recorder cards of at least 1GB each
 - Video interface cards
 - One card for each touch-screen monitor

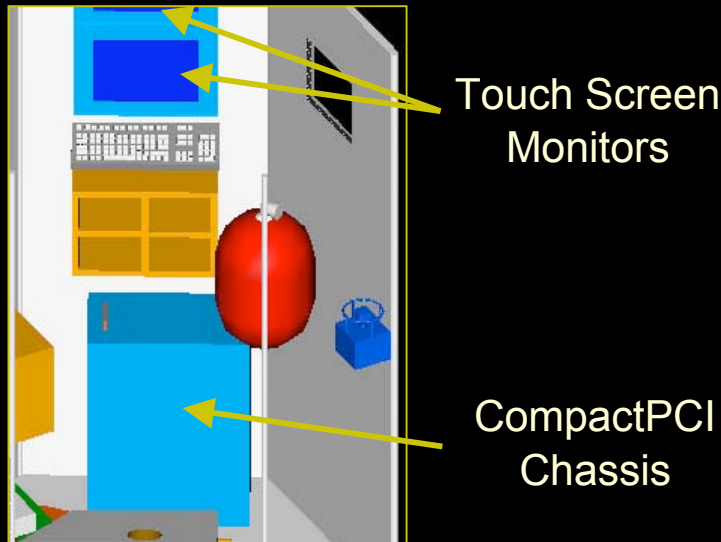

Single Board Computer

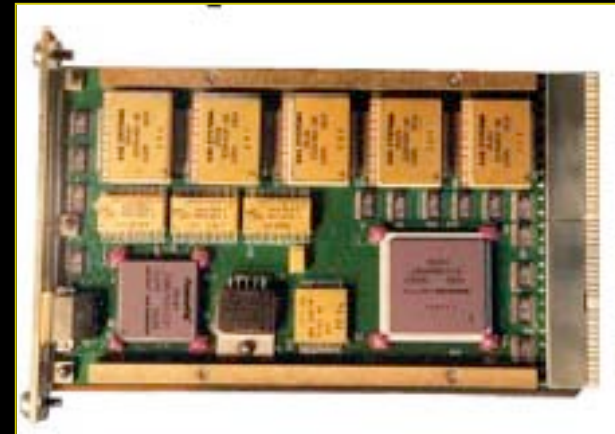

BAE Systems



Project SCOUT

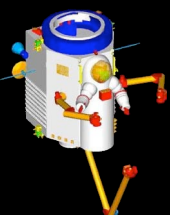

Unregistered HyperCam

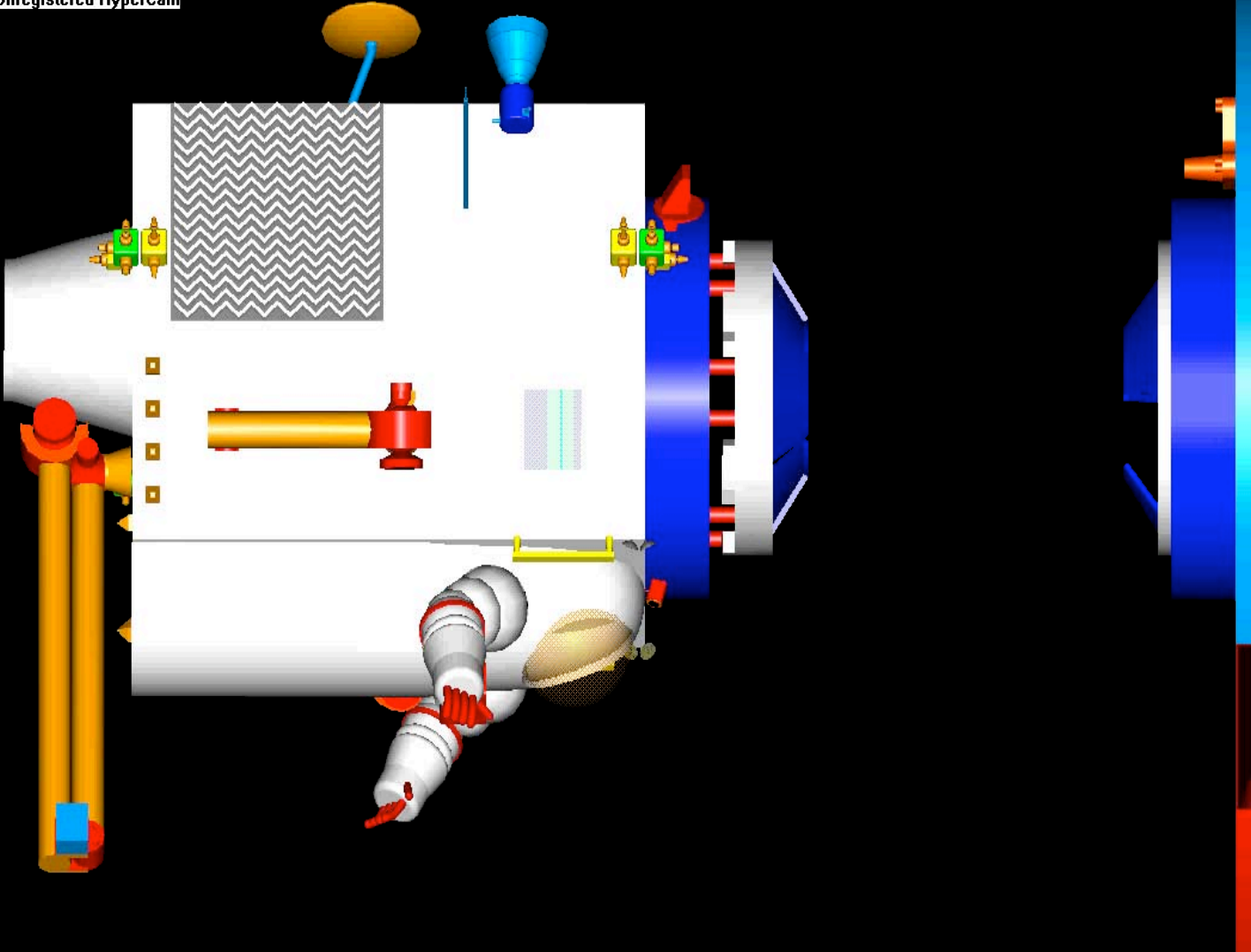

SCOUT



Project **SCOUT**



SCOUT

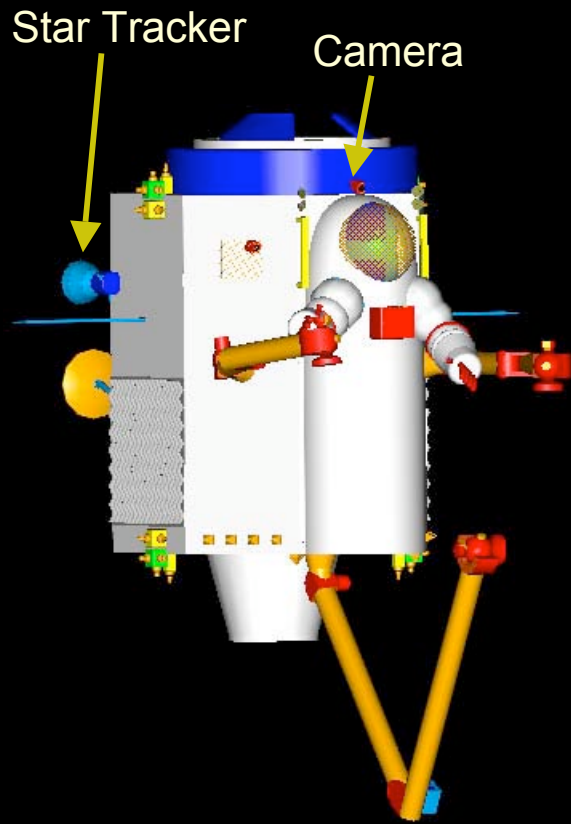

Front View

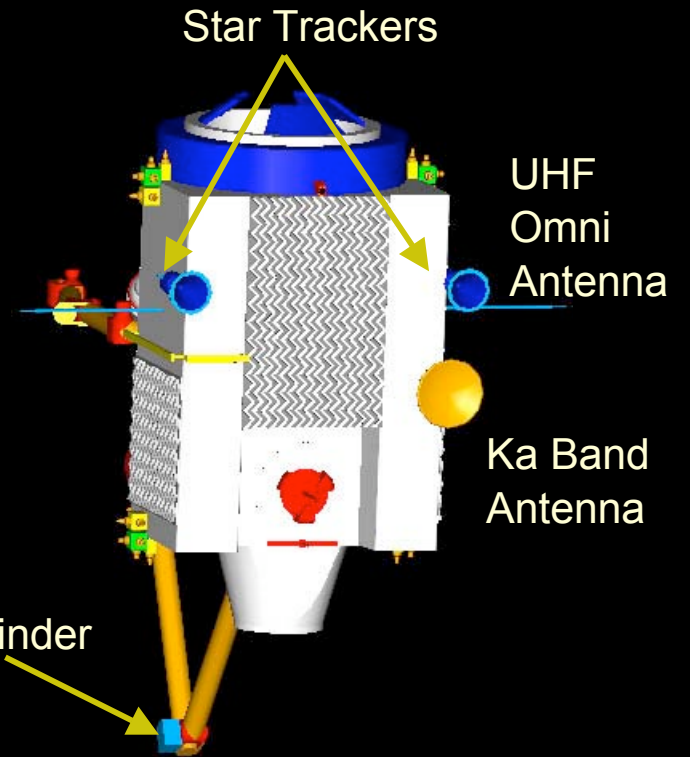

Rear View



Project **SCOUT**

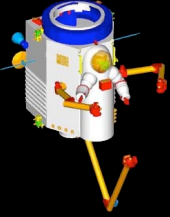

SCOUT

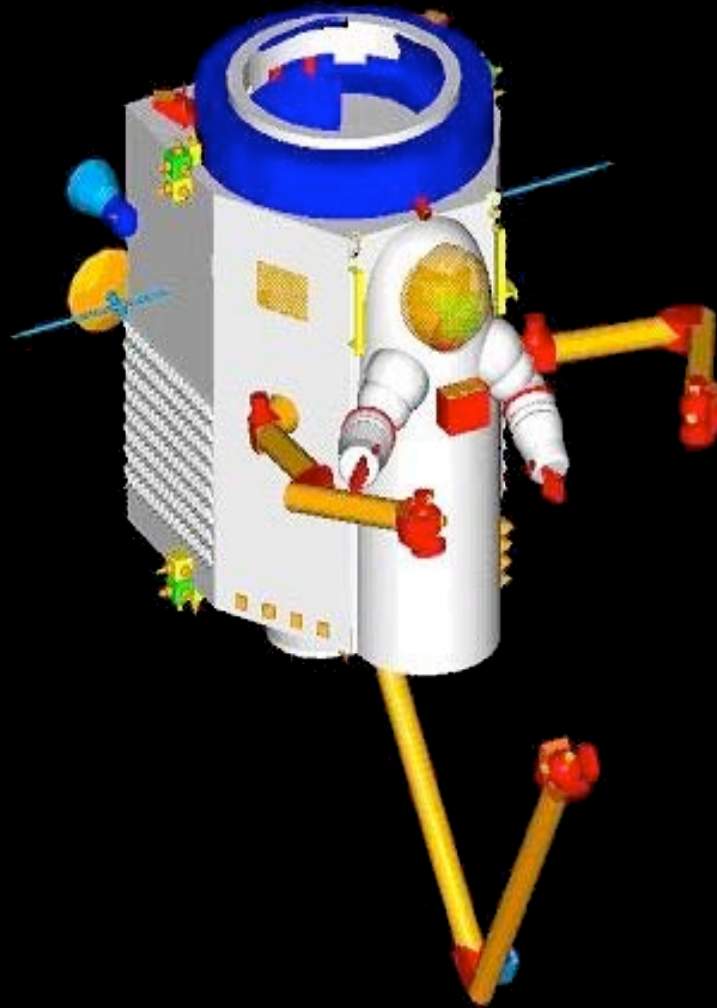

Project **SCOUT**

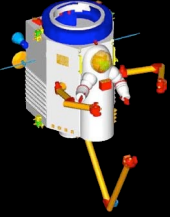

SCOUT

	EMU w/MMU	Robonaut	SCOUT
Max Sortie Duration	7hr	8hr	11hr
Max Sortie Distance	120m	25m	1000m
On Site Human Intel	Yes	No	Yes
Teleoperation Control	No	Yes	Yes
Human/Robotics Interaction	No	Yes	Yes
Autonomous Control	No	Yes	Yes
Single Person Op Capability	No	Yes	Yes
2-Hand Operation	No	Yes	Yes
Radiation Protection	3g/cm ²	N/A	4g/cm ²
Life Support	7hr + 0.5hr reserve	N/A	11hr + 2hr reserve
Bailout Systems	No	N/A	SHEEP/SAFER



Project **SCOUT**

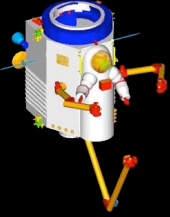

SCOUT

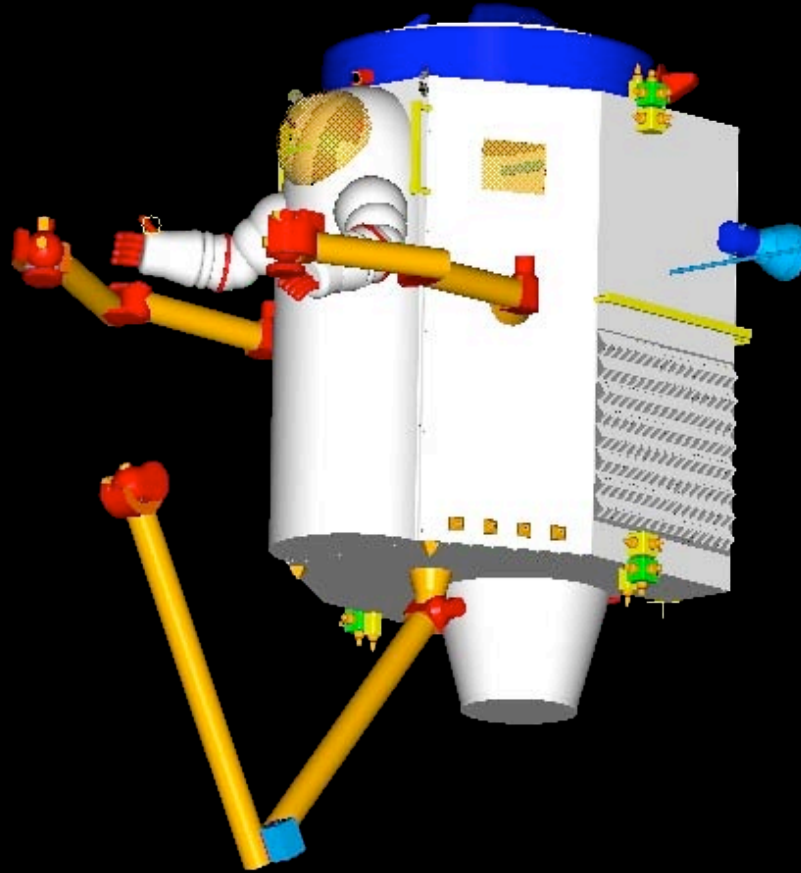



SCOUT

Project SCOUT



**Revolutionary Aerospace Systems Concepts
– Academic Linkage**

Conference

May 18-21, 2003

